

The background of the entire page is a vibrant red. Silhouetted against this red background are several construction workers and their work structures. On the left, a tall, vertical rebar structure is being worked on by three workers. In the center, another rebar structure stands. On the right, a third rebar structure is visible with a worker. The overall scene is one of active construction.

# YCR

**SOLUCIONES  
PARA DECORAR  
Y CONSTRUIR**

# 2023

**CONSTRUYENDO JUNTOS  
BUILDING TOGETHER**



# CONSTRUYENDO JUNTOS

## BUILDING TOGETHER

### LA CONSTRUCCIÓN EVOLUCIONA Y NOSOTROS CON ELLA

YCR Complementos "somos" una empresa joven y dinámica dedicada a la comercialización de productos para el profesional de la construcción ofreciendo una gama amplia de perfiles y sistemas de nivelación.

La construcción evoluciona y es por ello por lo que apostamos por las nuevas tendencias en el sector de la cerámica proporcionando soluciones innovadoras en decoración, nivelación y protección que ofrecen máxima eficacia y garantías probadas. Apostamos por la profesionalización de cada una de las familias de producto que aparecen en nuestro catálogo dando a nuestro cliente la gama más extensa en medidas y acabados.

Nuestro eslogan es "Soluciones para Decorar y Construir", sin embargo, nuestra máxima no sólo es esa, es también prestar un servicio de excelente calidad a nuestros clientes. Creemos que en los pequeños detalles reside el éxito y es por ello por lo que disponemos de stock de todos los artículos de nuestro catálogo, y así poder ofrecer una respuesta rápida y eficiente a las necesidades de nuestros clientes.

Nuestro equipo humano es nuestro principal activo intangible y es, gracias a ellos, por lo que marcamos la diferencia en el sector. Suscribimos el proverbio africano que dice: "Si quieres ir rápido, ve solo; si quieres llegar lejos, ve acompañado".

Llevamos más de 10 años de trayectoria profesional y personal en todo el territorio nacional y extranjero. Seguimos creciendo, seguimos evolucionando.

### CONSTRUCTION EVOLVES AND WE EVOLVE WITH IT

YCR Complementos "we are" a young and dynamic company dedicated to the commercialization of products for the construction professional, offering a wide range of profiles and leveling systems.

Construction evolves and that is why we are committed to new trends in the ceramic sector, providing innovative solutions in decoration, leveling and protection that offer maximum efficiency and demonstrated guarantees.

We are committed to the professionalization of each of the product families that appear in our catalog, giving our clients the most extensive range of sizes and finishes.

Our slogan is "Solutions for Decorating and Building;" however, our maxim is not only that, but also to provide an excellent quality service to our clients.

We believe that success lies in the small details and that is why we have stock of all the items in our catalogue, and thus be able to offer a quick and efficient response to the needs of our customers.

Our human team is our main intangible asset, and it is thanks to them that we make a difference in the sector. We subscribe to the African proverb that says: "If you want to go fast, go alone; If you want to go far, go together."

We have more than 10 years of professional and personal experience throughout the national and foreign territory. We continue to grow; we continue to evolve.

**YCR**

SOLUCIONES PARA DECORAR Y CONSTRUIR

**ÍNDICE INDEX**

**SOLUCIONES PARA LA COLOCACIÓN AZULEJO 3 TILE LAYING SOLUTIONS**

HYBRID System	4	Hybrid System
C-LEVEL® System	5	C-LEVEL® System
DUO-LEVEL® System	10	DUO-LEVEL® System
Y-LEVEL® System	12	Y-LEVEL® System
Distanciadores de Juntas	16	Joint Spacers
Grapas de Fachada	17	Facade Staples
MaxiPlot Suelo Técnico	19	Maxiplot
MaxiPlot Complementos	28	Accessories MaxiPlot
EuroPlot Suelo Técnico	30	Europlot
Herramientas de Mano	38	Hand Tools

**REMATES ACERO INOX AISI 304 41 SS PROFILES FOR THE TILE**

Listelos Cuadrados Inox AISI 304	42	Squared Profiles
Listelos Ultra-Fine	43	Ultra-Fine Profiles
Guardacanto Curvo y Plano Inox AISI 304	44	Curve & Straight Profile
Listelos U y 25 x 12mm Inox AISI 304	45	"U" & 25 x 12 mm Profile
Ángulo y Listelo Alfa Inox AISI 304	46	Angle & Alpha Profile
Listelo T y Nivel Oblicuo Inox AISI 304	47	"T" & Oblique Profile

**REMATES ALUMINIO 48 ALUMINIUM PROFILES FOR THE TILE**

Listelos LED	49	Led Profiles
Peldaños LED	50	Led Stair Noising
Listelos Lija	51	Brushed Profiles
Listelos Texturizados	52	Textured Profiles
Guardacantos Planos Texturizados	53	Straight Edge Textured Profiles
Listelos Madera	54	Wood Profiles
Guardacantos Planos Madera	55	Straight Edge Wood Profiles
Listelos 10 x 12 mm	56	Profiles 10 x 12 mm
Listelos Cuadrados	57	Square Profiles
Guardacantos Curvos	58	Curve Edge Profiles
Guardacantos Planos	59	Straight Edge Profiles
Listelos Canto Romo 12 x 12 mm	60	Round Edge Profiles 12 x 12 mm
Listelos Canto Romo 25 x 12 mm	61	Round Edge Profiles 25 x 12 mm
Listelos 5 x 12 mm	62	Profiles 5 x 12 mm
Perfiles Slim	63	Slim Profiles
Ángulo y Guardacantos Flecha	64	Angles & Arrow Profiles
Guardacantos Chaflán y Cruz	65	Chamfer Edge & Cross Profiles

**REMATES PVC Y RÚSTICOS 66 PVC PROFILES FOR THE TILE**

Listelos Rústicos	67	Rustic Profiles
Guardacantos Planos Rústicos	68	Straight Edge Rustic Profiles
Guardacantos Curvos Rústicos	69	Curve Edge Rustic Profiles
Listelos PVC 10 x 10 y 12 x 12 mm	70	PVC Square Profiles 10 x 10 y 12 x 12 mm
Guardacantos Curvos PVC	71	PVC Curve Edge Profiles
Guardacantos Planos y Ángulos PVC	72	PVC Straight & Angles Profiles

**PERFILES PARA PAVIMENTO 73 PROFILES FOR PAVEMENT**

Peldaños Rústicos P6	74	P6 Rustic Stair Noising
Peldaños Rústicos P7	75	P7 Rustic Stair Noising
Pletina T, Pletina Antideslizante y Peldaño P5	76	Antislipping Profiles & P5 Stair Noising
Peldaños P1 y P2	77	P1 & P2 Stair Noising
Peldaños P3	78	P3 Stair Noising
Peldaños P4	79	P4 Stair Noising
Vierteaguas V1 y V2 Aluminio	80	V1 & V2 Drip Edge
Separadores Pavimento Aluminio	81	Pavement Spacers
Niveles Magnum y Oblicuo Aluminio	82	Magnum & Oblique Level

**JUNTAS DE DILATACIÓN 83 EXPANSION JOINTS**

Junta Dilatación Reversible JD9	84	Reverse Expansion Joint JD9
---------------------------------	----	-----------------------------

Junta Dil. JD1, recambios JD1/JD9 y JD3 Al.	85	Interchangeable JD1 & JD3 Expansion Joint
Junta Dil. JD2 + Silicona y JD12 Perimetral	86	Joint+Silicone JD2 & Perimeter JD12 Expansion Joint
Junta Dil. JD4 y JD5 Inox AISI 304	87	SS JD4 & JD5 Expansion Joint
Junta Dil. JD6 y JD7 PVC	88	JD6 With Wing & JD7 Expansion Joint
Junta Dil. JD8 y Hormigón PVC	89	JD8 & Concrete Expansion Joints
Junta Dil. JD10 y JD11 Estructurales	90	JD10 & JD11 Structural Expansion Joints

**ESCOCIAS Y ZÓCALOS 93 SKIRTING BOARD & INTERNAL ANGLES**

Zócalo Z1 y Z1 LED Aluminio	94	Z1 Aluminium Skirting Board
Zócalo Z1 Esquina universal	95	Z1 Aluminium Universal Corner
Zócalo Z6 PVC	96	Z6 Extruded Polystyrene
Zócalo Z2 Aluminio	97	Z2 Aluminium Skirting Board
Zócalo Z4 y Z5 Aluminio	98	Z4 & Z5 Aluminium Skirting Board
Zócalo Z3 PVC	99	Z3 PVC Skirting Board
Escocia E1 Aluminio	100	E1 Aluminium Internal Angle
Escocia E2 Acero Inox AISI 304	101	E2 SS Internal Angle
Escocia E3 Aluminio y E4 PVC	102	E3 Aluminium Internal Angle

**ACCESORIOS PARA PAVÉS 103 GLASS BLOCKS ACCESSORIES**

Separador Para Pavés	104	Glass Block Spacer
Varilla Pavés Galvanizada	104	Galvanized Rod
Varilla F.V.	104	Fiberglass Rod
Perfil Terminal Curvo	105	Terminal Curve Profile
Perfil Terminal Recto	105	Terminal Straight Profile

**GUARDAVIVOS 106 CORNER PROFILES**

Perfiles Enlucido Yeso	107	Corner Profiles for Plaster
Perfiles Enlucido + Malla	108	PVC Plaster Profiles With Mesh
Perfiles Enlucido Invisibles	109	Invisible PVC Plaster Profiles
Perfiles Enlucido Monocapa	110	Monolayer Plaster Profiles
Guardavivos Enlucido Flexibles	111	Flexible Plaster Profiles
Guardavivo Auto-adhesivo ROLL	112	PVC Roll Self-Adhesive Plasterboard Profile
Guardavivos Cartón-Yeso	113	Plasterboard Profile

**COMPLEMENTOS PARA LA CONSTRUCCIÓN 117 ACCESSORIES FOR CONSTRUCTION**

Tubo Pasamuros y Berenjano	118	PVC Tube & Chamfer Strip
Armadura de Muro y Fijaciones	119	Wall Reinforcement & Fixings
Tacos Fijación para Aislamiento	120	Standard Fixing Plugs
Complementos Encofrado	121	Formworks Accessories Guard Rails
Rastrel PVC y Apoyaondas	122	PVC Under Tile Battens & Waves Spacers PP
Disuasor Antipájaros	123	Deterrents
Cintas Adhesivas	124	Adhesives Tapes

**MALLAS Y LÁMINAS 125 MEMBRANES & MESH**

WATERDRY®	126	WATERDRY®
Complementos WATERDY®	127	WATERDRY® Accessories
UNRIFT DRY®	128	UNRIFT DRY®
Mat Fibras de Vidrio y Velo	129	Fiberglass Mat & Velo
Mallas de Refuerzo	130	Reinforcing Mesh
Mallas Especiales	131	Specials Mesh
Fibras de Refuerzo y Resina Puente de Unión	132	Reinforcing Fibers and Resins
Plástico Solera	133	Foundation Plastic
Mallas para la construcción	134	Construction Mesh

**REGISTROS 135**

Armazones para puertas correderas	136	Door Frames for Sliding Doors
Registros de Fachada	137	Doors for Counters
Registros de Suelo	138	Floor Cap
Registros de Contador	139	Big Doors for Counters

**MATERIAL PROMOCIONAL 140 PROMOTIONAL MATERIAL**

**CONDICIONES GENERALES 144 GENERAL CONDITIONS**

**SOLUCIONES para la  
COLOCACIÓN del AZULEJO**  
TILE LAYING SOLUTIONS

**MODELO  
PATENTADO**  
PATENTED MODEL

# YCR HYBRID **C** LEVEL<sup>®</sup>

MADE IN ITALY CE

## !!! ELIGE CÓMO QUIERES HACERLO !!! CHOOSE HOW YOU WANT TO DO IT !!!

### 1 OPCIÓN / OPTION

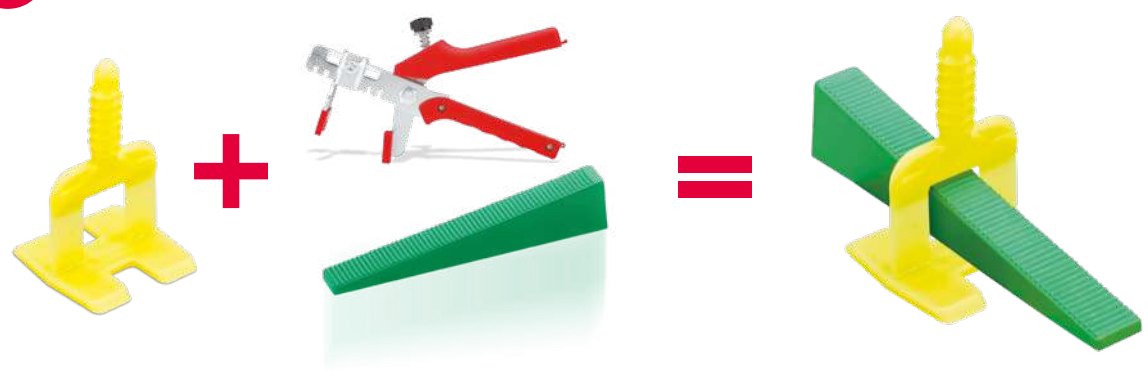

### 2 OPCIÓN / OPTION



**OPCIONAL:**  
**OPTIONAL:** +



Colocación del DISCO ÚNICO como protección antiabrasiva de cualquier superficie.  
Placement of the DISC as anti-abrasive protection for any surface.

**C LEVEL**®

MADE IN ITALY CE

**YCR**

**MODELO  
PATENTADO  
PATENTED MODEL**

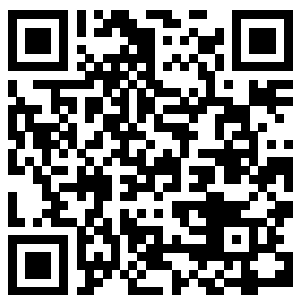

**You Tube**

**VIDEO TUTORIAL  
DE INSTALCIÓN  
DEL SISTEMA C LEVEL®**

**C LEVEL® SYSTEM INSTALLATION  
VIDEO-TUTORIAL**



**Kit C-LEVEL Rosca Auto-Extraíble + Calzo**

**C-LEVEL KIT**

<b>Código</b> Code	<b>Medida Junta</b> Tile Joint Width	<b>Packing</b> Packing
<b>4809P002001</b>	1 mm	100 Roscas / 200 Calzos
<b>4809P002002</b>	2 mm	100 Screws / 200 Clips
<b>4809P002003</b>	1 mm	50 Roscas / 100 Calzos
<b>4809P002004</b>	2 mm	50 Screws / 100 Clips



■ Calzos Standard  
Standard Clips

■ Calzos Piedra-Mármol  
Stone-Marble Clips

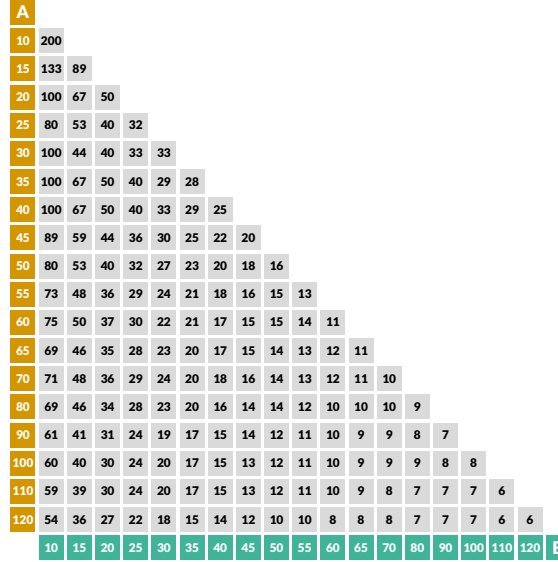

Número aproximado de calzos por m<sup>2</sup> necesarios según formato de baldosa

Approximate number of clips per sq. m. needed according to the tile format.

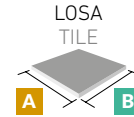

**Calzo C-LEVEL STANDARD**  
Standard Clip C-LEVEL

Código Code	Medida Junta Tile Joint Width	Color Colour	Espesor Azulejo Tile Thickness	Uds./Bolsa Pcs./ Bag	Bolsas / Caja Bags / Box
4805P000007	0,5 mm	Azul Blue	6-13 mm	200 uds./pcs.	10 Bolsas/Bags
4805P000001	1 mm	Amarillo Yellow			
4805P000016	1,5 mm	Naranja Orange			
4805P000002	2 mm	Blanco White			
4805P000003	3 mm	Rosa Pink			
4805P000017	4 mm	Marrón Brown			
4805P000018	5 mm	Gris Grey			

**Calzo Espesorado C-LEVEL PIEDRA-MÁRMOL**  
C-LEVEL Stone-Marmol Clips

Código Code	Medida Junta Tile Joint Width	Color Colour	Espesor Azulejo Tile Thickness	Uds./Bolsa Pcs./ Bag	Bolsas / Caja Bags / Box
4805P000009	1 mm	Amarillo Yellow	13-20 mm	200 uds./pcs.	10 Bolsas/Bags
4805P000011	2 mm	Blanco White			
4805P000013	3 mm	Rosa Pink			
4805P000014	4 mm	Marrón Brown			
4805P000015	5 mm	Gris Grey			



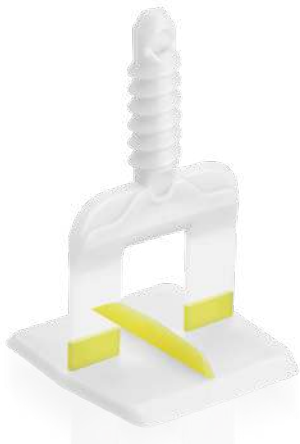

**Calzo C-LEVEL CRUZ**  
C-LEVEL CROSS

Código Code	Medida Junta Tile Joint Width	Color Colour	Espesor Azulejo Tile Thickness	Uds./Bolsa Pcs./ Bag	Bolsas/Caja Bags / Box
<b>4806P000001</b>	1 mm	Amarillo Yellow	6-13 mm	200 uds./pcs.	10 Bolsas/Bags
<b>4806P000002</b>	2 mm	Blanco White			
<b>4806P000005</b>	3 mm	Rosa Pink			



Pieza especial para la colocación **CRUZ**  
Special piece for **CRUZ** placement



**Calzo C-LEVEL T**  
C-LEVEL T

Código Code	Medida Junta Tile Joint Width	Color Colour	Espesor Azulejo Tile Thickness	Uds./Bolsa Pcs./ Bag	Bolsas/Caja Bags / Box
<b>4807P000001</b>	1 mm	Amarillo Yellow	6-13 mm	200 uds./pcs.	10 Bolsas/Bags
<b>4807P000002</b>	2 mm	Blanco White			
<b>4807P000005</b>	3 mm	Rosa Pink			



Pieza especial para la colocación **T**  
Special piece for **T** placement



## Complementos

### Complements



#### Alicate Plástico

##### Leveling Plastic Plier

Código Code	Acabado Finish	Packing Packing
4801P000000	Alicate PP PP Plier	10 uds./pcs.



#### Alicate Metálico

##### Leveling Metallic Plier

Código Code	Acabado Finish	Packing Packing
4801G120000	Alicate Metálico Metallic Plier	10 uds./pcs.

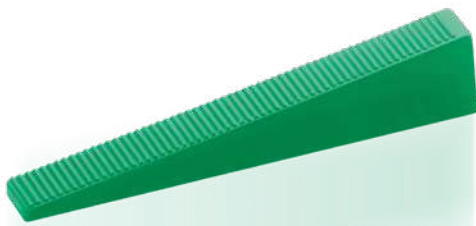

#### Cuña LEVEL MINI

##### Mini Wedge LEVEL

Código Code	Color Colour	Medida Size	Uds. / Bolsa Pcs. / Bag	Bolsas / Caja Bags / Box
4803P000004	Verde Green	95 x 10 x 20 mm	100 uds./pcs.*	20 Bolsas/Bags
4803P000003	Verde Green	95 x 10 x 20 mm	200 uds./pcs.	10 Bolsas/Bags

\*CAJAS INDIVISIBLES / INDIVISIBLE BOXES



■ Rosca  
Screw

■ Disco  
Disc



**Rosca Auto-Extraíble C-LEVEL**  
Self-Extracting C-Level

Código Code	Color Colour	Uds./Bolsa Pcs./Bag	Bolsas/Caja Bags/Box
4808P000001	Rojo Red	100 uds./pcs.	5 Bolsas/Bags
4808P000002	Rojo Red	50 uds./pcs.	10 Bolsas/Bags



**Disco Único Polipropileno Ø55 x 1 mm**  
Polypropylene Protective Disc

Código Code	Color Colour	Medida Size	Uds./Bolsa Pcs./Bag	Bolsas/Caja Bags/Box
4810P000003	Transparente Transparent	Ø55 x 1 mm	100 uds./pcs.	25 Bolsas/Bags



Colocación del DISCO ÚNICO como protección antiabrasiva de cualquier superficie.  
Placement of the DISC as anti-abrasive protection for any surface.



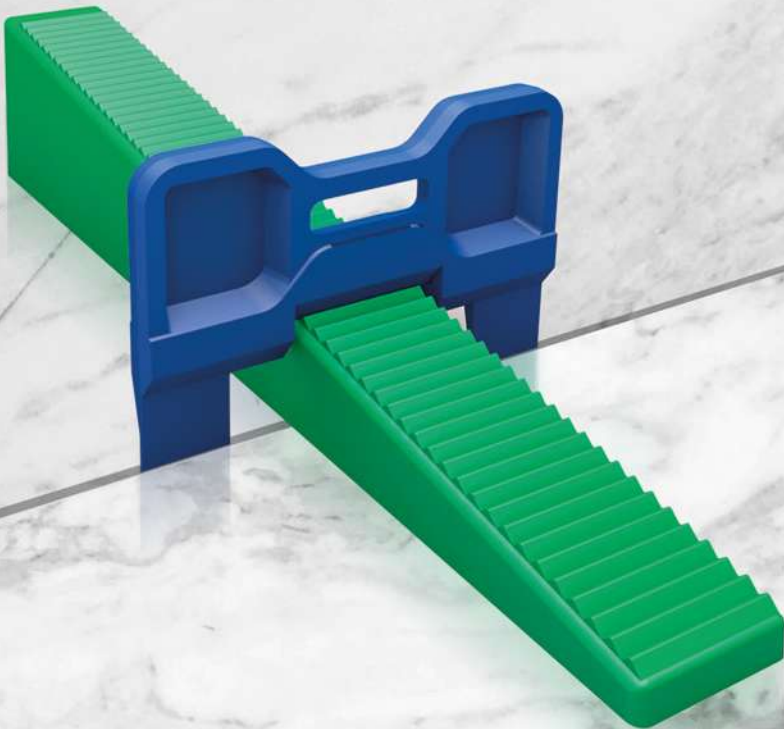
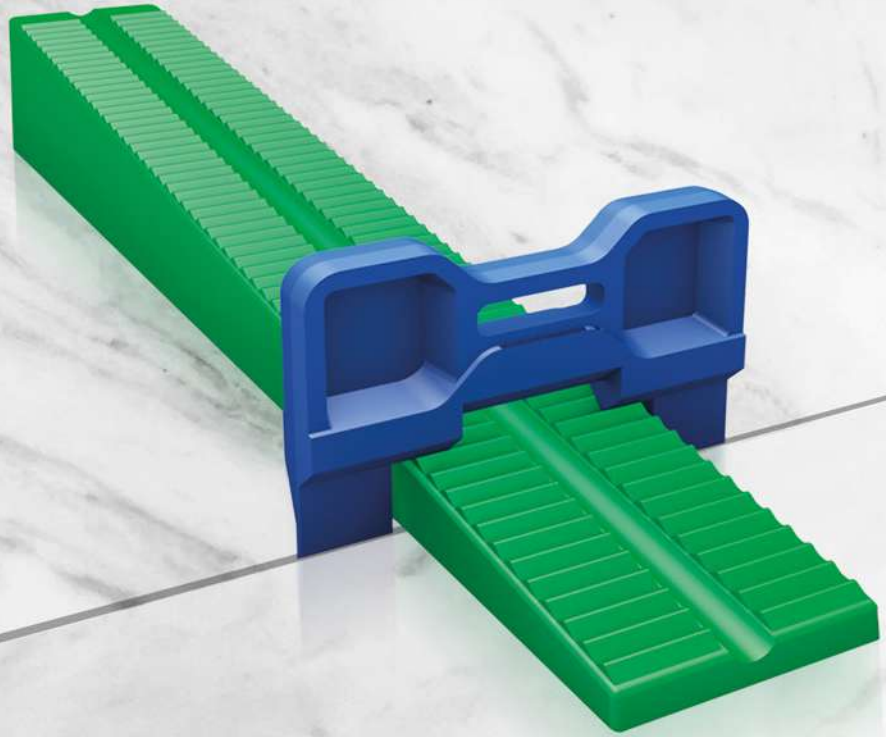



## Calzo DUO-LEVEL

Standard Clip DUO-Level

Código Code	Medida Junta Tile Joint Width	Color Colour	Espesor Azulejo Tile Thickness	Uds./Bolsa Pcs./ Bag	Bolsas/Caja Bags / Box
<b>4812P000050</b>	0,5 mm	Azul Blue			
<b>4812P000001</b>	1 mm	Blanco White	8-13 mm	250 uds./pcs.	10 Bolsas/Bags
<b>4812P000002</b>	2 mm	Amarillo Yellow			

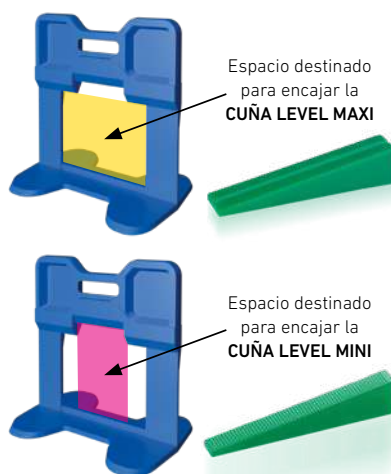

## Cuña LEVEL MINI

Mini Wedge LEVEL

Código Code	Color Colour	Medida Size	Uds./Bolsa Pcs./ Bag	Bolsas/Caja Bags / Box
<b>4803P000004</b>	Verde Green	95 x 10 x 20 mm	100 uds./pcs.*	20 Bolsas/Bags
<b>4803P000003</b>	Verde Green	95 x 10 x 20 mm	200 uds./pcs.	10 Bolsas/Bags

\*CAJAS INDIVISIBLES / INDIVISIBLE BOXES

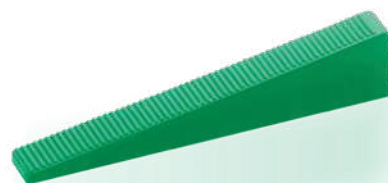

## Cuña LEVEL MAXI

Maxi Wedge Level

Código Code	Color Colour	Medida Size	Uds./Bolsa Pcs./ Bag	Bolsas/Caja Bags / Box
<b>4803P000002</b>	Verde Green	95 x 18 x 20 mm	100 uds./pcs.*	20 Bolsas/Bags
<b>4803P000001</b>	Verde Green	95 x 18 x 20 mm	200 uds./pcs.	10 Bolsas/Bags

\*CAJAS INDIVISIBLES / INDIVISIBLE BOXES



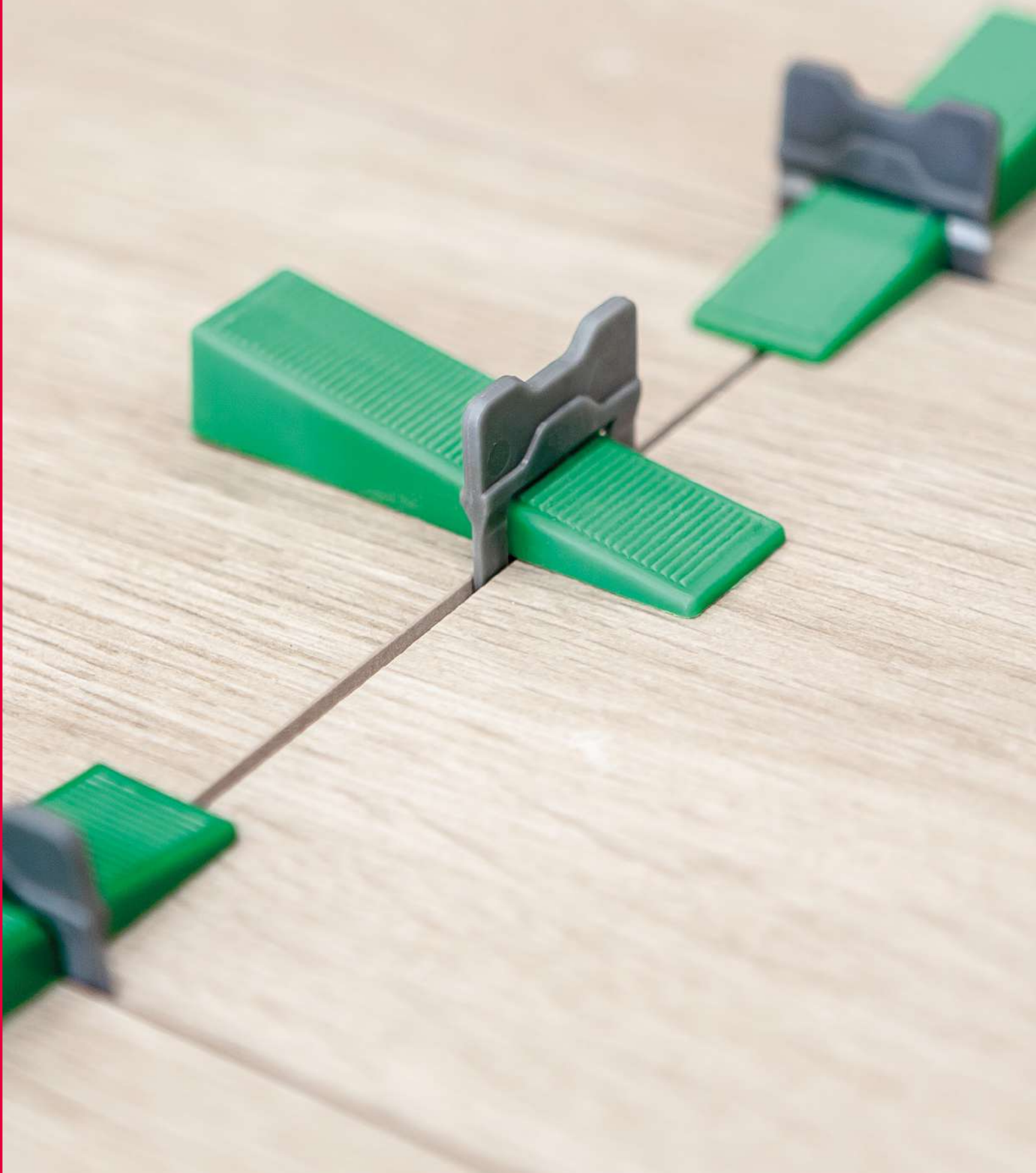

A																			B		
10	200																				
15	133	89																			
20	100	67	50																		
25	80	53	40	32																	
30	100	44	40	33	33																
35	100	67	50	40	29	28															
40	100	67	50	40	33	29	25														
45	89	59	44	36	30	25	22	20													
50	80	53	40	32	27	23	20	18	16												
55	73	48	36	29	24	21	18	16	15	13											
60	75	50	37	30	22	21	17	15	15	14	11										
65	69	46	35	28	23	20	17	15	14	13	12	11									
70	71	48	36	29	24	20	18	16	14	13	12	11	10								
80	69	46	34	28	23	20	16	14	14	12	10	10	10	9							
90	61	41	31	24	19	17	15	14	12	11	10	9	9	8	7						
100	60	40	30	24	20	17	15	13	12	11	10	9	9	9	8	8					
110	59	39	30	24	20	17	15	13	12	11	10	9	8	7	7	7	6				
120	54	36	27	22	18	15	14	12	10	10	8	8	8	7	7	7	6	6			
	10	15	20	25	30	35	40	45	50	55	60	65	70	80	90	100	110	120	B		

Número aproximado de calzos por m<sup>2</sup> necesarios según formato de baldosa

Approximate number of clips per sq. m. needed according to the tile format.

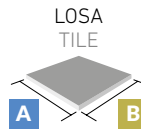

### Kit de Nivelación Y-LEVEL 1 y 2 mm

Y-LEVEL Kit 1 and 2 mm

**ALICATE METÁLICO**  
METALLIC PLIER



**ALICATE PP**  
PP PLIER



**Medida Junta**  
Tile Joint Width

**Packing**  
Packing

<b>4805P002501</b>	<b>4804P002501</b>	1 mm	250 calzos + 200 cuñas + 1 Alicate 250 clips + 200 wedges + 1 Plier
<b>4805P001001</b>	<b>4804P001001</b>	1 mm	100 calzos + 100 cuñas + 1 Alicate 100 clips + 100 wedges + 1 Plier
<b>4805P002502</b>	<b>4804P002502</b>	2 mm	250 calzos + 200 cuñas + 1 Alicate 250 clips + 200 wedges + 1 Plier
<b>4805P001002</b>	<b>4804P001002</b>	2 mm	100 calzos + 100 cuñas + 1 Alicate 100 clips + 100 wedges + 1 Plier





MADE IN ITALY CE

YCR

## Calzo Standard

Standard Clip

## Calzo Especial para pavimentos espesados

Special Clip for thickened pavements



### Calzo Y-LEVEL STANDARD

Standard Clip Y-Level

Código Code	Medida Junta Tile Joint Width	Color Colour	Espesor Azulejo Tile Thickness	Uds./Bolsa Pcs./Bag	Bolsas/Caja Bags/Box
4802P000018	0,5 mm	Azul Blue	8-13 mm	250 uds./pcs.	10 Bolsas/Bags
4802P000001	1 mm	Blanco White			
4802P000015	1,5 mm	Naranja Orange			
4802P000002	2 mm	Amarillo Yellow			
4802P000003	3 mm	Rosa Pink			
4802P000005	4 mm	Marrón Brown			
4802P000020	5 mm	Gris Grey			



### Calzo Y-LEVEL PIEDRA-MÁRMOL

Stone-Marble Clip Y-Level

Código Code	Medida Junta Tile Joint Width	Color Colour	Espesor Azulejo Tile Thickness	Uds./Bolsa Pcs./Bag	Bolsas/Caja Bags/Box
<b>NEW</b> 4802P000023	0,5 mm	Blanco White	13-20 mm	250 uds./pcs.	10 Bolsas/Bags
4802P000014	1 mm	Gris Grey			
4802P000004	2 mm	Azul Osc. Dark Blue			
4802P000006	3 mm	Azul Claro Light Blue			
<b>NEW</b> 4802P000021	4 mm	Marrón Brown			
<b>NEW</b> 4802P000022	5 mm	Gris Grey			



## Complementos

### Accessories

#### Alicate Plástico Leveling Plastic Plier

Código Code	Acabado Finish	Packing Packing
4801P000000	Alicate PP PP Plier	10 uds./pcs.



#### Alicate Metálico Leveling Metallic Plier

Código Code	Acabado Finish	Packing Packing
4801G120000	Alicate Metálico Metallic Plier	10 uds./pcs.



#### Cuña LEVEL Maxi Maxi Wedge Level

Código Code	Color Colour	Medida Size	Uds./Bolsa Pcs./Bag	Bolsas/Caja Bags/Box
4803P000002	Verde Green	95 x 18 x 20 mm	100 uds./pcs.*	20 Bolsas/Bags
4803P000001	Verde Green	95 x 18 x 20 mm	200 uds./pcs.	10 Bolsas/Bags

\*CAJAS INDIVISIBLES / INDIVISIBLE BOXES



#### Disco Único Polipropileno Ø55 x 1 mm Polypropylene Protective Disc

Código Code	Color Colour	Medida Size	Uds./Bolsa Pcs./Bag	Bolsas/Caja Bags/Box
4810P000003	Transparente Transparent	Ø55 x 1 mm	100 uds./pcs.	25 Bolsas/Bags

Colocación del DISCO ÚNICO como suplemento para azulejos Slim. Permite la aplicación del Sistema Y-LEVEL en azulejos con un mínimo de espesor de 3 mm.  
Placing the Disc as a supplement for slim tiles. Allows the application of the Y-Level System on tiles with a minimum thickness of 3 mm.





## Distanciadores de juntas

Joint Spacers

MADE IN ITALY

### Crucetas para Azulejos

Tile Cross Spacers

Código Code	Medida Size	Uds. x Bolsa Uds. x Bag	Packing Packing
4901P000001	1 mm	200 uds./pcs.	50 bolsas / bags
4901P000015	1,5 mm		
4901P000002	2 mm		
4901P000003	3 mm		
4901P000004	4 mm		
4901P000005	5 mm		
4901P000007	7 mm		
4901P000010	10 mm		



### Crucetas Tipo T para Azulejos

Tile T Cross Spacers

Código Code	Medida Size	Uds. x Bolsa Uds. x Bag	Packing Packing
4903P000001	1 mm	200 uds./pcs.	50 bolsas / bags
4903P000002	2 mm		
4903P000003	3 mm		
4903P000004	4 mm		
4903P000005	5 mm		
4903P000007	7 mm		
4903P000010	10 mm		



### Cuñas Alicatado

Wedges

Código Code	Medida Size	Uds. x Bolsa Uds. x Bag	Packing Packing
4902P000005	0,5 mm	200 uds./pcs.	50 bolsas / bags



## ■ Grapas Fachada Acero Inox Aisi 304

### Facade Staples Stainless Steel AISI 304

#### Grapa OCULTA Acero Inox Aisi 304

##### Hidden Staples Stainless Steel AISI 304



Informe nº-21904589 / Ensayo de carga.  
Report nº-21904589 / Load test.

Código Code	Modelo Model	Medida Junta Tile Joint Width	Acabado Finish	Tipo Type
KC000000003	G01	Mínima / Minimum	Oculta / Hidden	Continuación / Continuation
KC000000002	G02	Mínima / Minimum	Oculta / Hidden	Arranque / Start
KC000000001	GU	8 mm	Universal / Universal	Continuación / Continuation



G01

Continuación Junta mínima  
Continuation Minimum Joint



G02

Arranque Oculta  
Hidden Start



GU

Continuación Junta 8 mm  
Continuation Joint 8 mm

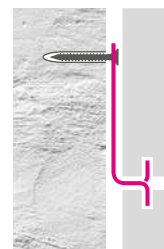

Esquema de instalación  
Installation

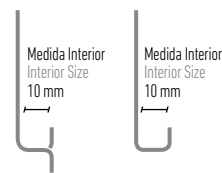

1 Tornillo Acero Inox + 1 Taco Nylon  
INCLUDED X GRAPA

1 Inox Screw + 1 Nylon Wall Plug  
INCLUDED X STAPLE

#### Grapa VISTA Acero Inox Aisi 304

##### Visible Staples Stainless Steel AISI 304



Informe nº-21904589 / Ensayo de carga.  
Report nº-21904589 / Load test.

Código Code	Modelo Model	Medida Junta Tile Joint Width	Acabado Finish	Tipo Type
KC000000005	GV1	Mínima / Minimum	Vista / Visible	Continuación / Continuation
KC000000004	GV2	Mínima / Minimum	Vista / Visible	Arranque / Start
KC000000001	GU	8 mm	Universal / Universal	Continuación / Continuation

LACADO EN COLORES RAL BAJO PEDIDO / LACQUERED IN RAL COLORS UPON REQUEST



GV1

Continuación Junta mínima  
Continuation Minimum Joint



GV2

Arranque Vista  
Visible Start



GU

Continuación Junta 8 mm  
Continuation Joint 8 mm

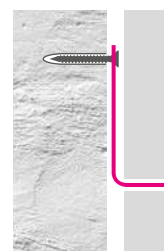

Esquema de instalación  
Installation

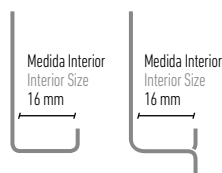

1 Tornillo Acero Inox + 1 Taco Nylon  
INCLUDED X GRAPA

1 Inox Screw + 1 Nylon Wall Plug  
INCLUDED X STAPLE



STAINLESS  
**STEEL**  
AISI 304

■ Grapas Fachada Acero Inox Aisi 304  
Facade Staples Stainless Steel AISI 304

**NEW**

**Grapa G03 Acero Inox Aisi 304**  
G03 Staples Stainless Steel AISI 304

Código Code	Medida Junta Tile Joint Width	Acabado Finish	Tipo Type
<b>KC000000006</b>	Mínima Minimum	Oculto Hidden	Continuación Continuation



G03



1 Tornillo Acero Inox + 1 Taco Nylon  
INCLUIDOS X GRAPA  
1 Inox Screw + 1 Nylon Wall Plug  
INCLUDED X STAPLE



Esquema de instalación  
Installation

**NEW**

**Adaptador Radial para Grapa G03**  
Radial Adapter for Staples G03

Código Code	Acabado Finish	Packing
<b>60076000001</b>	Acero Inox Stainless Steel	1 ud./pc.

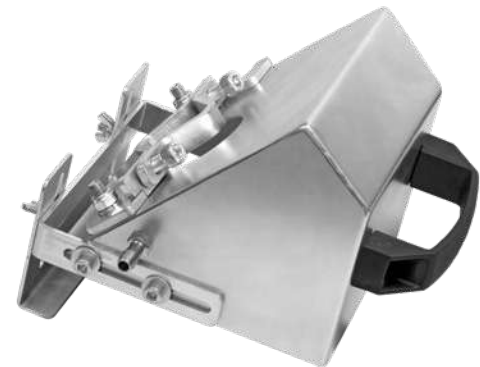



YCA



**MAXILOT®**  
**YCR**



CABEZAL JUNTA de 2 o 3 mm  
Regulación de altura de forma manual  
mediante Aro Giratorio

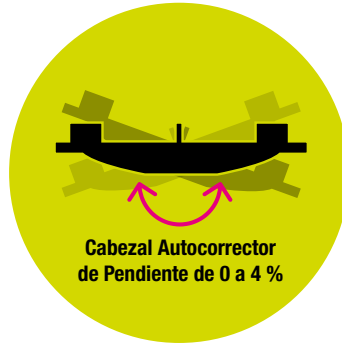

CABEZAL JUNTA de 4 mm  
Regulación de altura de forma manual o  
mecánica mediante Llave Reguladora

## Principales cualidades de la nueva serie MAXILOT

Realizados con materiales resistentes y reciclables, este sistema permite una carga de hasta 2.000 kg. Evitando la colocación de otros materiales para la instalación del mismo se elimina un peso y un gasto superfluo.



La naturaleza de los materiales de fabricación de los plots permite eliminar tanto las vibraciones del tránsito sobre el pavimento, como crear una capa de aislamiento acústico y térmico.

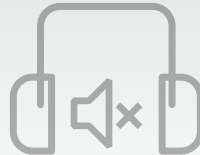

Las instalaciones con plots permiten un acceso rápido y sin obras a instalaciones o reparaciones de conductos debajo del mismo. Las instalaciones con plots tienen además las ventajas de un peso ligero y una larga durabilidad.



**Autonivelante  
de 0° a 4°  
desnivel**

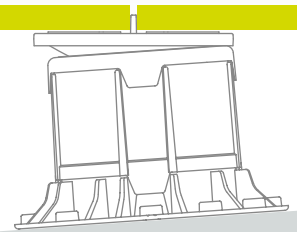
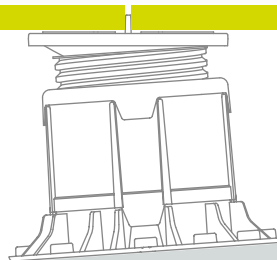
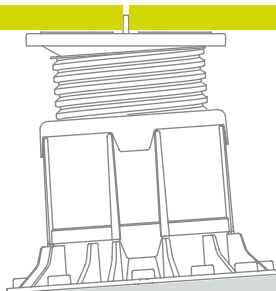

**MaxiPlot 15 / 20 mm**  
MaxiPlot 15 / 20 mm

Medida Size	Junta 3 mm Joint 3 mm	Junta 4 mm Joint 4 mm	Packing Packing
15 / 20 mm	<b>4701P021503</b>	<b>4701P021504</b>	30 uds./pcs.

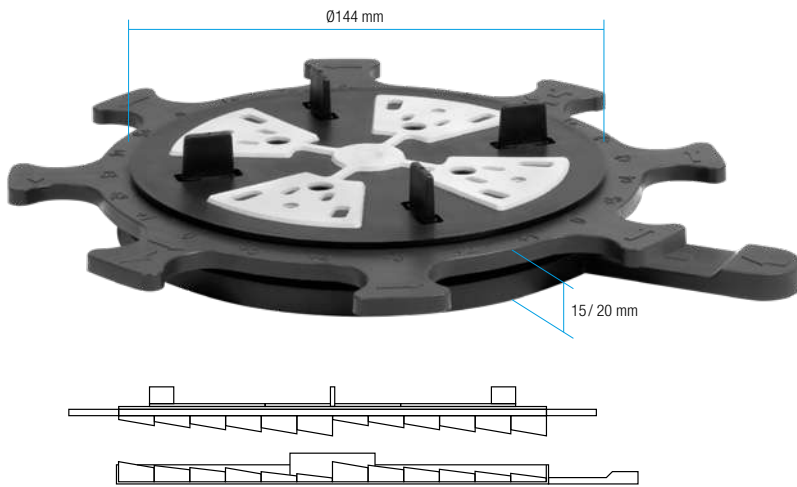

**MaxiPlot Extensión**  
MaxiPlot Extension

Medida Size	MaxiPlot Extensión MaxiPlot Extension	Packing Packing
5 mm	<b>4701P020500</b>	280 uds./pcs.





**MAXILOT®**

**YCR**

**NEW**

**MaxiPlot 40 / 51 mm Junta 2 / 3 / 4 mm**  
 MaxiPlot 40 / 51 mm Joint 2 / 3 / 4 mm

Medida Size	Junta 2 mm Joint 2 mm	Junta 3 mm Joint 3 mm	Junta 4 mm Joint 4 mm	Packing Packing
40 / 51 mm	<b>4702P024051</b>	<b>4703P024051</b>	<b>4704P024051</b>	50 uds./pcs.
LLAVE (Solo para Plot con junta de 4 mm) / KEY (Only for Plot with 4 mm joint)			<b>4701P020503</b>	1 ud./pc.

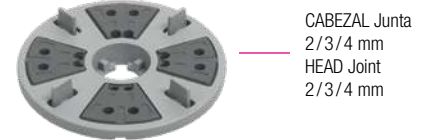
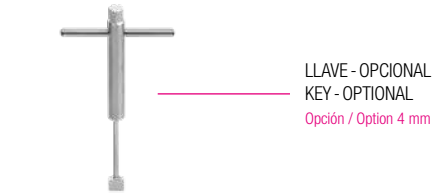

Opción / Option 2 & 3 mm



Opción / Option 4 mm



Junta/Joint 2 o 3 mm





**MaxiPlot 51 / 75 mm Junta 2 / 3 / 4 mm**  
 MaxiPlot 51 / 75 mm Joint 2 / 3 / 4 mm

Medida Size	Junta 2 mm Joint 2 mm	Junta 3 mm Joint 3 mm	Junta 4 mm Joint 4 mm	Packing Packing
51 / 75 mm	<b>4702P025175</b>	<b>4703P025175</b>	<b>4704P025175</b>	50 uds./pcs.
LLAVE (Solo para Plot con junta de 4 mm) / KEY (Only for Plot with 4 mm joint)			<b>4701P020503</b>	1 ud./pc.



Junta/Joint 2 o 3 mm

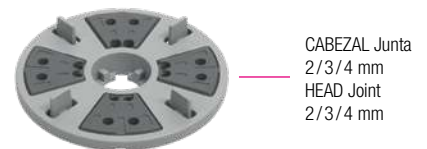
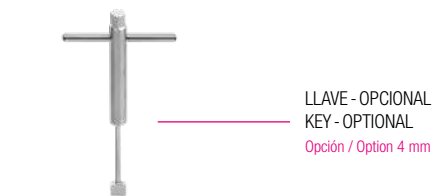



**MAXILOT®**

**YCR**

**NEW**

**MaxiPlot 74 / 121 mm Junta 2 / 3 / 4 mm**

MaxiPlot 74 / 121 mm Joint 2 / 3 / 4 mm

Medida Size	Junta 2 mm Joint 2 mm	Junta 3 mm Joint 3 mm	Junta 4 mm Joint 4 mm	Packing Packing
74 / 121 mm	<b>4702P027412</b>	<b>4703P027412</b>	<b>4704P027412</b>	30 uds./pcs.
LLAVE (Solo para Plot con junta de 4 mm) / KEY (Only for Plot with 4 mm joint)			<b>4701P020503</b>	1 ud./pc.



Junta/Joint 2 o 3 mm



LLAVE - OPCIONAL  
KEY - OPTIONAL  
Opción / Option 4 mm



CABEZAL Junta 2/3/4 mm  
HEAD Joint 2/3/4 mm



ROSCA H61 mm  
SCREW



ARO GIRATORIO  
ROTATING RING  
Opción / Option 2 & 3 mm



ARO FIJO  
FIXED RING  
Opción / Option 4 mm



EXTENSIÓN H35 mm



BASE H23 mm

**MaxiPlot 121 / 215 mm- Junta 2 / 3 / 4 mm**  
 MaxiPlot 121 / 215 mm Joint 2 / 3 / 4 mm

Medida Size	Junta 2 mm Joint 2 mm	Junta 3 mm Joint 3 mm	Junta 4 mm Joint 4 mm	Packing Packing
121 / 215 mm	<b>4702P021221</b>	<b>4703P021221</b>	<b>4704P021221</b>	20 uds./pcs.
LLAVE (Solo para Plot con junta de 4 mm) / KEY (Only for Plot with 4 mm joint)			<b>4701P020503</b>	1 ud./pc.



LLAVE - OPCIONAL  
 KEY - OPTIONAL  
 Opción / Option 4 mm



CABEZAL Junta  
 2/3/4 mm  
 HEAD Joint  
 2/3/4 mm



ROSCA  
 SCREW H105 mm



ARO GIRATORIO  
 ROTATING RING  
 Opción / Option 2 & 3 mm



ARO FIJO  
 FIXED RING  
 Opción / Option 4 mm



EXTENSIÓN H70 mm



BASE H35 mm



**Cabezal Autocorrector  
 de Pendiente de 0 a 4 %**



Junta/Joint 2 o 3 mm



**MAXILOT®**

**YCR**

**NEW**

**MaxiPlot 214 / 308 mm Junta 2 / 3 / 4 mm**  
 MaxiPlot 214 / 308 mm Joint 2 / 3 / 4 mm

Medida Size	Junta 2 mm Joint 2 mm	Junta 3 mm Joint 3 mm	Junta 4 mm Joint 4 mm	Packing Packing
214 / 308 mm	<b>4702P022130</b>	<b>4703P022130</b>	<b>4704P022130</b>	12 uds./pcs.
LLAVE (Solo para Plot con junta de 4 mm) / KEY (Only for Plot with 4 mm joint)			<b>4701P020503</b>	1 ud./pc.

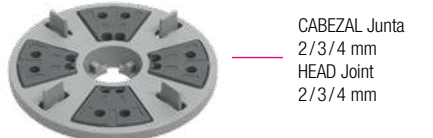
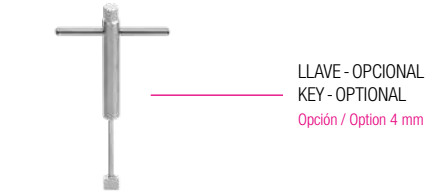

Junta/Joint 2 o 3 mm

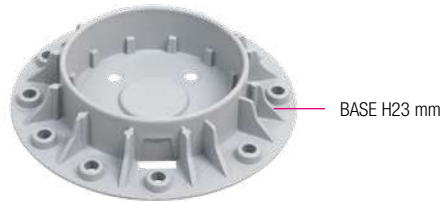
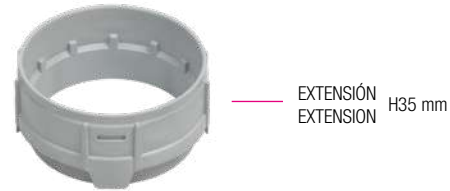
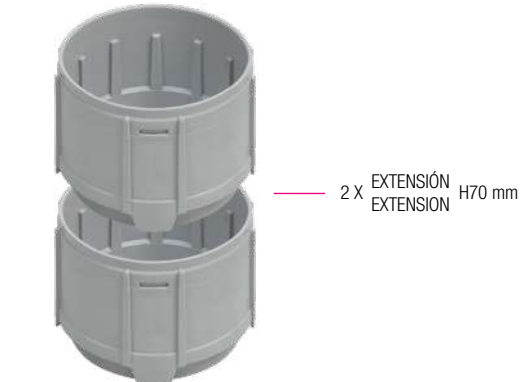

**MaxiPlot 296 / 390 mm Junta 2 / 3 / 4 mm**  
 MaxiPlot 296 / 390 mm Joint 2 / 3 / 4 mm

Medida Size	Junta 2 mm Joint 2 mm	Junta 3 mm Joint 3 mm	Junta 4 mm Joint 4 mm	Packing Packing
296 / 390 mm	<b>4702P022939</b>	<b>4703P022939</b>	<b>4704P022939</b>	10 uds./pcs.
LLAVE (Solo para Plot con junta de 4 mm) / KEY (Only for Plot with 4 mm joint)			<b>4701P020503</b>	1 ud./pc.



Junta/Joint 2 o 3 mm



LLAVE - OPCIONAL  
KEY - OPTIONAL  
Opción 4 mm / Option 4 mm



CABEZAL Junta  
2/3/4 mm  
HEAD Joint  
2/3/4 mm



ROSCA  
SCREW H105 mm



ARO GIRATORIO  
ROTATING RING  
Opción 2 y 3 mm / Option 2 & 3 mm



ARO FIJO  
FIXED RING  
Opción 4 mm / Option 4 mm



3 X EXTENSIÓN  
EXTENSION H70 mm

EXTENSIÓN  
EXTENSION H35 mm

BASE H35 mm



**MAXILOT®**

**YCR**



**MaxiPlot Complementos**  
MaxiPlot Accessories

Código Code	Descripción Description	Packing Packing
4701P020501	Cabezal Rastrel Aluminio Aluminum Batten Head	10 uds./pcs.
4701P020502	Cabezal Rastrel Madera Wood Batten Head	10 uds./pcs.

**Cabezal Rastrel Aluminio**  
Aluminum Batten Head

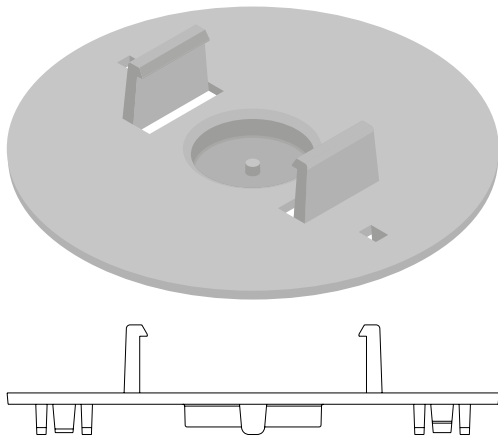

**Cabezal Rastrel Madera**  
Wood Batten Head

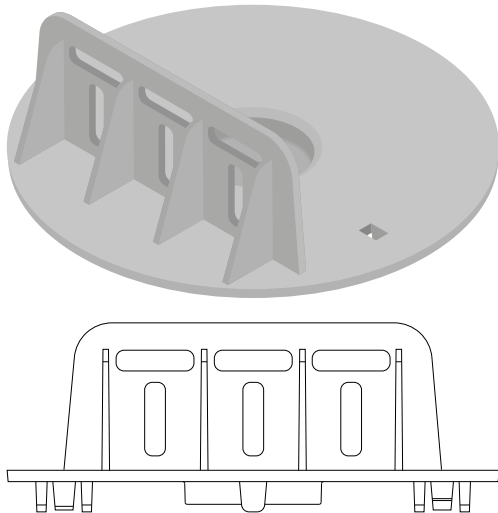

**MaxiPlot Complementos**  
MaxiPlot Accessories

Código Code	Descripción Description	Packing Packing
<b>4701P020507</b>	Kit Cerramiento Vertical Vertical Enclosure Kit	10 uds./pcs.
<b>4701P020506</b>	Junta PP Perimetral Perimeter PP Board	10 uds./pcs.

**Maxiplot Kit Cerramiento Vertical Acero Inox**  
Maxiplot Stainless Steel Vertical Enclosure Kit

Pieza Superior  
Top Piece

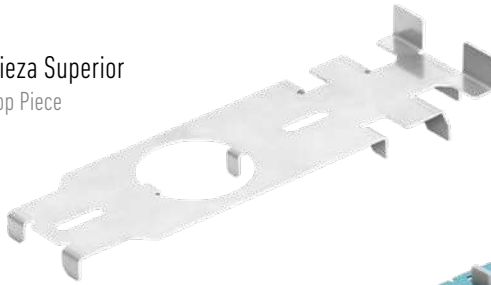

Pieza Inferior  
Bottom Piece

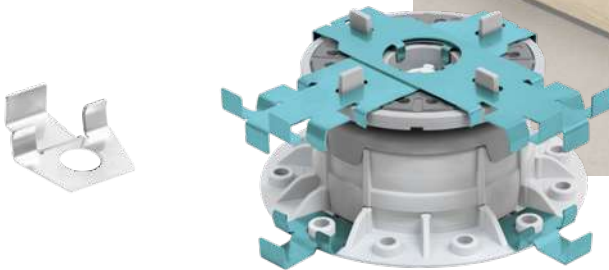

**Junta PP Perimetral**  
Perimeter PP Board

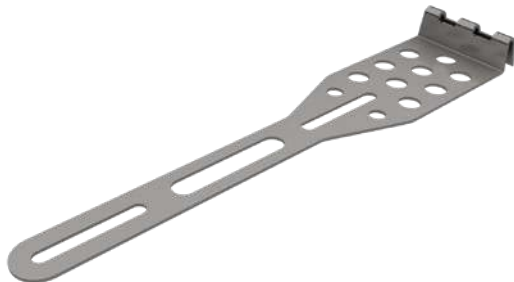



**EuroPlot 10 mm**  
EuroPlot 10 mm

Código Code	Base Losa Slab Base	Altura Height	Material Material	Packing Packing
<b>4701P180010</b>	100 mm	10 mm	Polipropileno	280 uds./pcs.
<b>4700P000001</b>	BASE AMORTIGUADORA CAUCHO OPCIONAL - SHOCK ABSORBING RUBBER BASE			

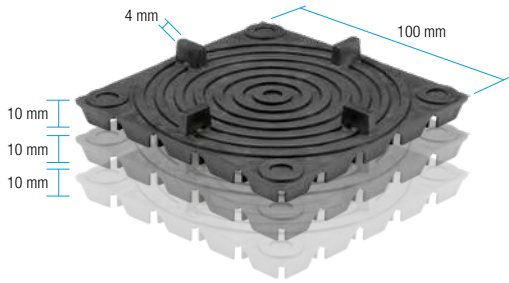

**EuroPlot 15 mm**  
EuroPlot 15 mm

Código Code	Base Losa Slab Base	Altura Height	Material Material	Packing Packing
<b>4701P180015</b>	100 mm	15 mm	Polipropileno	280 uds./pcs.
<b>4700P000001</b>	BASE AMORTIGUADORA CAUCHO OPCIONAL - SHOCK ABSORBING RUBBER BASE			

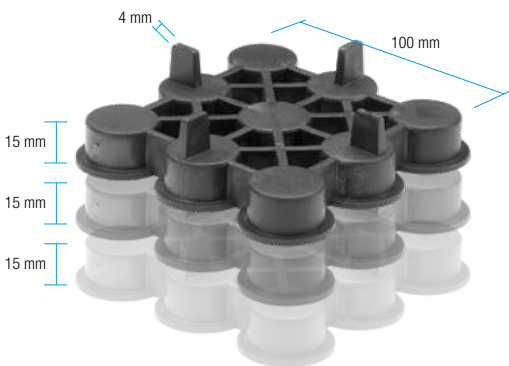



**EuroPlot 25 / 135 mm**  
EuroPlot 25 / 135 mm

Medida mm Size mm	Desnivel 0% Slope 0%	Desnivel 1% Slope 1%	Desnivel 2% Slope 2%	Packing Packing
25 / 35	X	4702P182535	X	100 uds./pcs.
35 / 50	4701P183550	4702P183550	4703P183550	100 uds./pcs.
50 / 70	4701P185070	4702P185070	4703P185070	130 uds./pcs.
70 / 100	4701P187010	4702P187010	4703P187010	115 uds./pcs.
100 / 135	4701P181013	4702P181013	4703P181013	100 uds./pcs.
<b>4700P000001</b> BASE AMORTIGUADORA CAUCHO OPCIONAL - SHOCK ABSORBING RUBBER BASE				

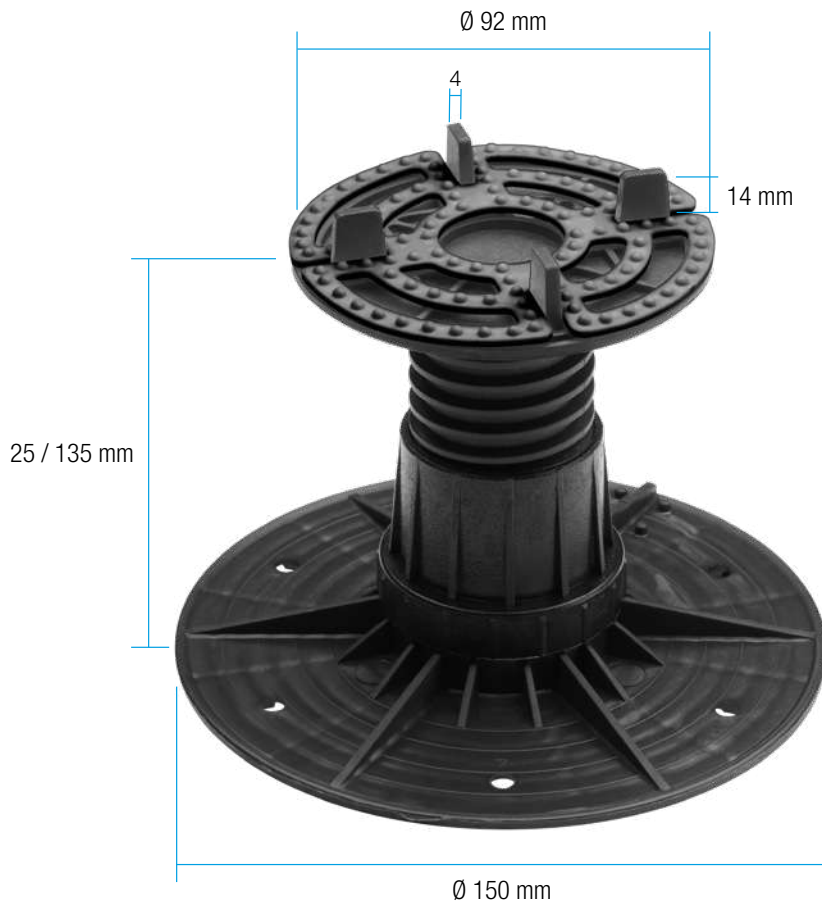



**EuroPlot 65 / 130 mm**  
EuroPlot 65 / 130 mm

Medida mm Size mm	Desnivel 0% Slope 0%	Desnivel 1.5% Slope 1.5%	Packing Packing
65 / 100	<b>4704P186510</b>	<b>4705P186510</b>	75 uds./pcs.
100 / 130	<b>4704P181013</b>	<b>4705P181013</b>	65 uds./pcs.

**4700P000001** BASE AMORTIGUADORA CAUCHO OPCIONAL - SHOCK ABSORBING RUBBER BASE

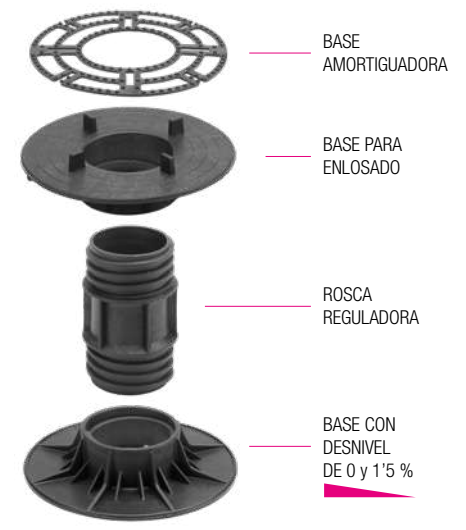

**EuroPlot 130 / 220 mm**  
EuroPlot 130 / 220 mm

Medida mm Size mm	Desnivel 0% Slope 0%	Desnivel 1% Slope 1%	Desnivel 2% Slope 2%	Packing Packing
130 / 220	<b>4704P181322</b>	<b>4706P181322</b>	<b>4707P181322</b>	45 uds./pcs.
<b>4700P000001</b>	BASE AMORTIGUADORA CAUCHO OPCIONAL - SHOCK ABSORBING RUBBER BASE			

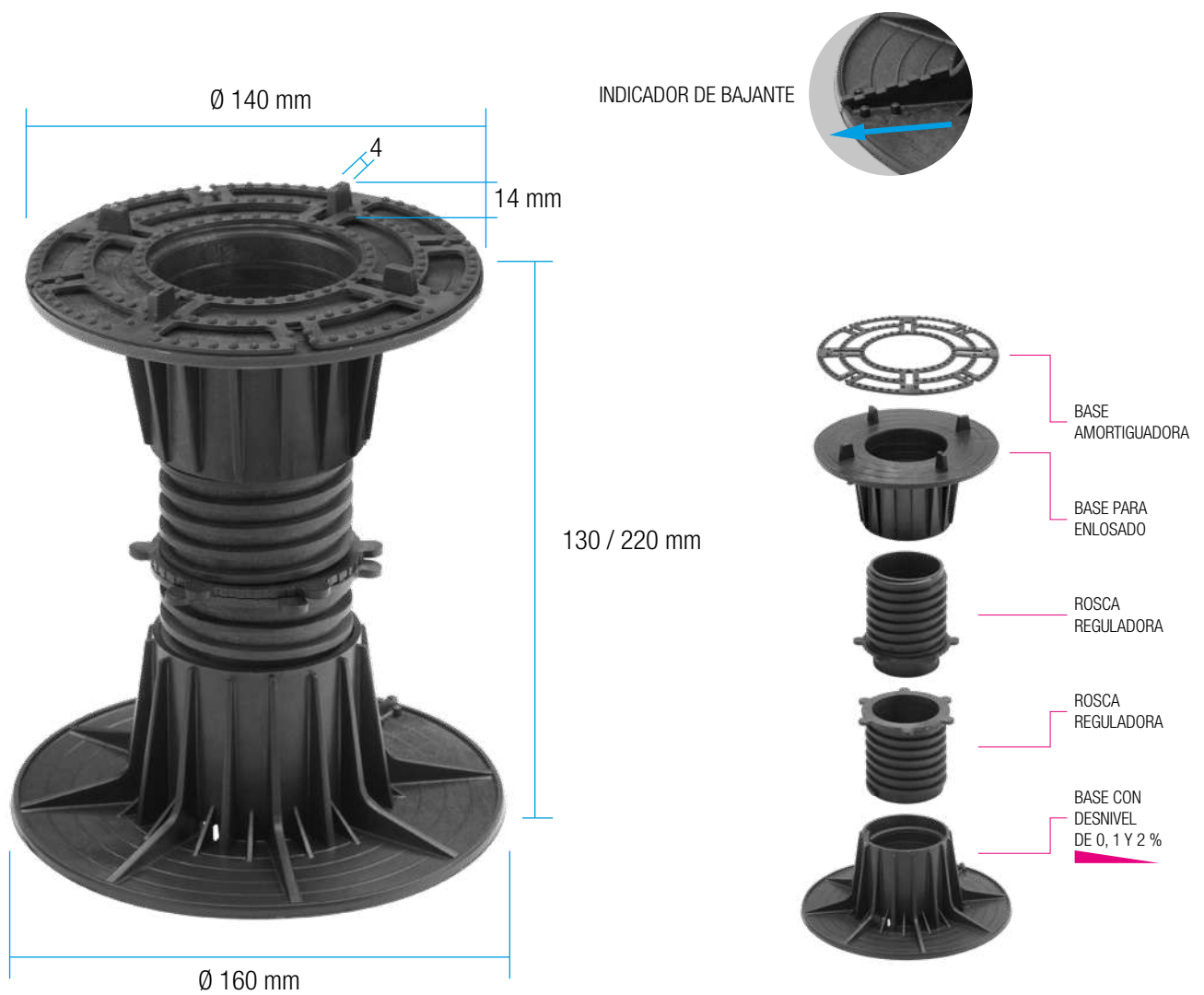



**EuroPlot 220 / 310 mm**  
EuroPlot 220 / 310 mm

Medida mm Size mm	Desnivel 0% Slope 0%	Desnivel 1% Slope 1%	Desnivel 2% Slope 2%	Packing Packing
220 / 310	<b>4704P182231</b>	<b>4706P182231</b>	<b>4707P182231</b>	35 uds./pcs.
<b>4700P000001</b>	BASE AMORTIGUADORA CAUCHO OPCIONAL - SHOCK ABSORBING RUBBER BASE			



**EuroPlot 310 / 400 mm**  
EuroPlot 310 / 400 mm

Medida mm Size mm	Desnivel 0% Slope 0%	Desnivel 1% Slope 1%	Desnivel 2% Slope 2%	Packing Packing
310 / 400	<b>4704P183140</b>	<b>4706P183140</b>	<b>4707P183140</b>	30 uds./pcs.
<b>4700P000001</b>	BASE AMORTIGUADORA CAUCHO OPCIONAL - SHOCK ABSORBING RUBBER BASE			



310 / 400 mm

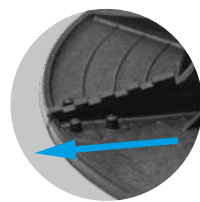

INDICADOR DE BAJANTE

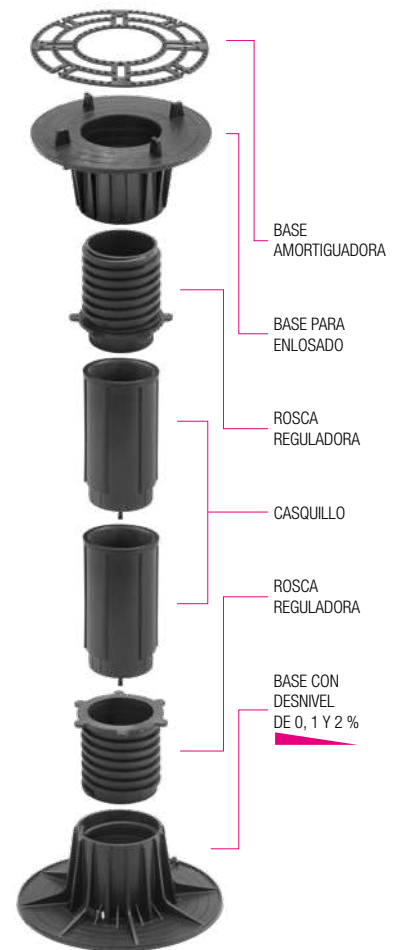



**EuroPlot 400 / 670 mm**  
EuroPlot 400 / 670 mm

Medida mm Size mm	Desnivel 0% Slope 0%	Desnivel 1% Slope 1%	Desnivel 2% Slope 2%	Packing Packing
400 / 490	<b>4704P184049</b>	<b>4706P184049</b>	<b>4707P184049</b>	30 uds./pcs.
490 / 580	<b>4704P184958</b>	<b>4706P184958</b>	<b>4707P184958</b>	25 uds./pcs.
580 / 670	<b>4704P185867</b>	<b>4706P185867</b>	<b>4707P185867</b>	25 uds./pcs.
<b>4700P000001</b>	BASE AMORTIGUADORA CAUCHO OPCIONAL - SHOCK ABSORBING RUBBER BASE			



INDICADOR DE BAJANTE

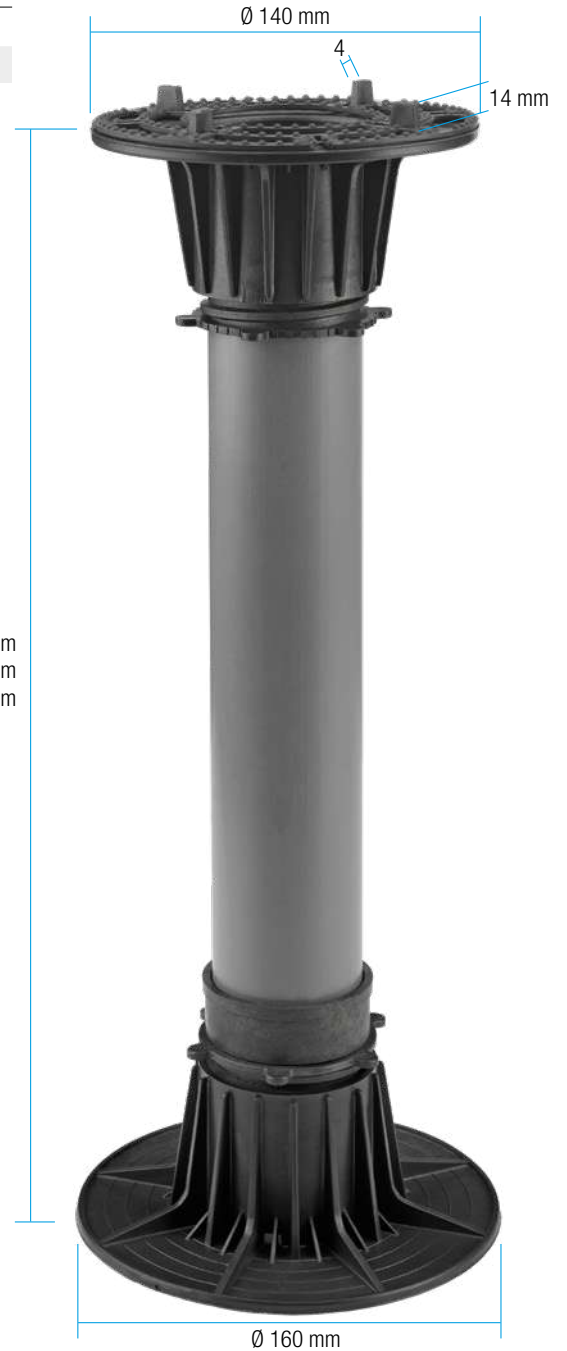

### Corrector Pendiente EUROPLOT 5 % Apilable

Código Code	Base Losa Slab Base	Pendiente Slope	Material Material	Packing Packing
4708P180000	100 mm	5 %	Polipropileno	140 uds./pcs.



### Tuercas Bloqueo EUROPLOT 1 Juego (derecha-izquierda)

Código Code	Material Material	Packing Packing
4710P180000	Polipropileno	500 uds./pcs.



### Tuerca Bloqueo EUROPLOT 25/135 mm

Código Code	Material Material	Packing Packing
4709P180000	Polipropileno	500 uds./pcs.





## Herramientas de mano

### Hand Tools

#### Kit Talocha + 2 Estropajos Fine / Strong

Trowel for Cleaning

Código Code	Medida Size	Acabado Finish	Packing Packing
1001H000019	25 x 12 x 1 cm	Plástico Plastic	25 uds./pcs.
Código Recambio Spare Parts Code	Medida Size	Acabado Finish	Packing Packing
1001H000020	25 x 12 cm	Blanco / White Fine	20 uds./pcs.
1001H000021	25 x 12 cm	Negro / Black Strong	20 uds./pcs.



#### Llana Dentada Plástico + Acero

ABS Handle and Notched Steel Plate

Código Code	Medida Llana Float Size	Medida Diente Tooth Size	Diente Tooth	Packing Packing
1001H000022	12 x 28 cm	8 x 8 mm		12 uds./pcs.
1001H000023	12 x 28 cm	10 x 10 mm		12 uds./pcs.
1001H000024	12 x 28 cm	12 x 12 mm		12 uds./pcs.
1001H000025	12 x 28 cm	15 x 15 mm		12 uds./pcs.
1001H000026	12 x 28 cm	20 x 15 mm		12 uds./pcs.



#### Llana Dentada Madera + Acero

Wooden Handle with Notched Steel Plate

Código Code	Medida Llana Float Size	Medida Diente Tooth Size	Diente Tooth	Packing Packing
1001H000027	12 x 28 cm	7 x 7 mm		12 uds./pcs.
1001H000028	12 x 28 cm	10 x 10 mm		12 uds./pcs.
1001H000029	12 x 28 cm	12 x 12 mm		12 uds./pcs.
1001H000030	12 x 28 cm	15 x 15 mm		12 uds./pcs.
1001H000031	12 x 28 cm	20 x 15 mm		12 uds./pcs.



#### Llana Dentada Madera + Acero Inox

Wooden Handle with SS Plate

Código Code	Medida Llana Float Size	Medida Diente Tooth Size	Diente Tooth	Packing Packing
1001H000032	12 x 28 cm	7 x 7 mm		12 uds./pcs.
1001H000033	12 x 28 cm	10 x 10 mm		12 uds./pcs.
1001H000034	12 x 28 cm	12 x 12 mm		12 uds./pcs.
1001H000035	12 x 28 cm	15 x 15 mm		12 uds./pcs.
1001H000036	12 x 28 cm	20 x 15 mm		12 uds./pcs.



## Herramientas de mano

### Hand Tools



#### Talocha Rejunte Mango Intercambiable + Goma

Plastic Support with Interchangeable Rubber Plate

Código Code	Medida Size	Acabado Finish	Packing Packing
1001H000007	25 x 11 cm	Rojo Red	12 uds./pcs.



#### Recambio Goma

Spare Parts

Código Code	Medida Size	Acabado Finish	Packing Packing
1001H000008	25 x 11 cm	Rojo Red	12 uds./pcs.



#### Talocha Rejunte Goma

Plastic Support with Rubber Plate

Código Code	Medida Size	Acabado Finish	Packing Packing
1001H000009	25 x 11 cm	Azul Blue	12 uds./pcs.



#### Talocha Rejunte Quality Ergonómico

Plastic Support with Rubber Plate Top Quality

Código Code	Medida Size	Acabado Finish	Packing Packing
1001H000004	25 x 11 cm	Azul Blue	6 uds./pcs.



#### Remolinador Quality Triangular Alto Rendimiento

Triangler Finishing Float

Código Code	Largo Length	Ancho Width	Grosor Thickness	Packing Packing
1001H000001	23 cm	12 cm	28 mm	36 uds./pcs.



#### Remolinador Quality Rectangular Alto Rendimiento

Rectangular Finishing Float

Código Code	Largo Length	Ancho Width	Grosor Thickness	Packing Packing
1001H000002	23 cm	12 cm	28 mm	36 uds./pcs.

YCR



## Herramientas de mano

### Hand Tools

#### Esponja Mango Intercambiable

Interchangeable Support with Sponge Plate

Código Code	Medida Size	Color Colour	Absorción Absorption	Packing Packing
1001H000010	29 x 15 x 4 cm	Tabaco Tobacco	Standard Standard	30 uds./pcs.
1001H000011	29 x 15 x 4 cm	Amarillo Yellow	Media Medium	30 uds./pcs.
1001H000012	29 x 15 x 3 cm	Hydrocell Hydrocell	Máxima Maximun	30 uds./pcs.



#### Recambio Esponja

Spare for Interchangeable Polishing Trowel

Código Code	Medida Size	Color Colour	Absorción Absorption	Packing Packing
1001H000016	29 x 15 x 4 cm	Tabaco Tobacco	Standard Standard	40 uds./pcs.
1001H000017	29 x 15 x 4 cm	Amarillo Yellow	Media Medium	40 uds./pcs.
1001H000018	29 x 15 x 3 cm	Hydrocell Hydrocell	Máxima Maximun	40 uds./pcs.



#### Esponja Mango Plástico

Plastic Support with Sponge Plate

Código Code	Medida Size	Color Colour	Absorción Absorption	Packing Packing
1001H000013	29 x 15 x 4 cm	Tabaco Tobacco	Standard Standard	30 uds./pcs.
1001H000014	29 x 15 x 4 cm	Amarillo Yellow	Media Medium	30 uds./pcs.
1001H000015	29 x 15 x 3 cm	Hydrocell Hydrocell	Máxima Maximun	30 uds./pcs.



#### Esponja Mixta Limpieza

Abrasive Sponge

Código Code	Largo Length	Ancho Width	Grosor Thickness	Packing Packing
1001H000006	19,5 cm	12 cm	60 mm	40 uds./pcs.



#### Esponja Standard Limpieza

Polyester Sponge

Código Code	Largo Length	Ancho Width	Grosor Thickness	Packing Packing
1001H000005	19,5 cm	12 cm	60 mm	30 uds./pcs.



STAINLESS  
**STEEL**  
AISI 304

**REMATES** para el **AZULEJO**  
PROFILES for the TILE

STAINLESS  
STEEL  
AISI 304



## Listelos Cuadrados

Squared Profiles

Listelo Acero Inox 8 x 8 / 10 x 10 / 12 x 12 / 16 x 16 mm  
Inox Profiles 8 x 8 / 10 x 10 / 12 x 12 / 16 x 16 mm

Código Code	Medida Size	Acabado Finish	Longitud Length	Packing Packing
01011430808	8 x 8 mm	Brillo Polished	2,60 m	20 uds./pcs.
01011450808	8 x 8 mm	Lija Brushed	2,60 m	20 uds./pcs.
01011431010	10 x 10 mm	Brillo Polished	2,60 m	25 uds./pcs.
01011451010	10 x 10 mm	Lija Brushed	2,60 m	25 uds./pcs.
01011431212	12 x 12 mm	Brillo Polished	2,60 m	25 uds./pcs.
01011451212	12 x 12 mm	Lija Brushed	2,60 m	25 uds./pcs.
01011441212	12 x 12 mm	Mate Matt	2,60 m	25 uds./pcs.
01011431616	16 x 16 mm	Brillo Polished	2,60 m	14 uds./pcs.

### Terminal / Esquina

Terminal / Corner

Código Code	Medida Size	Acabado Finish	Longitud Length	Packing Packing
01021431212	12 x 12 mm	Brillo Polished	Terminal/Esquina	Terminal/Corner 5 uds./pcs.
01021451212	12 x 12 mm	Lija Brushed	Terminal/Esquina	Terminal/Corner 5 uds./pcs.
01021441212	12 x 12 mm	Mate Matt	Terminal/Esquina	Terminal/Corner 5 uds./pcs.

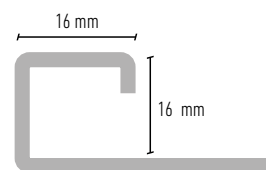
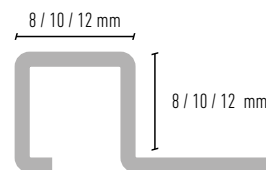
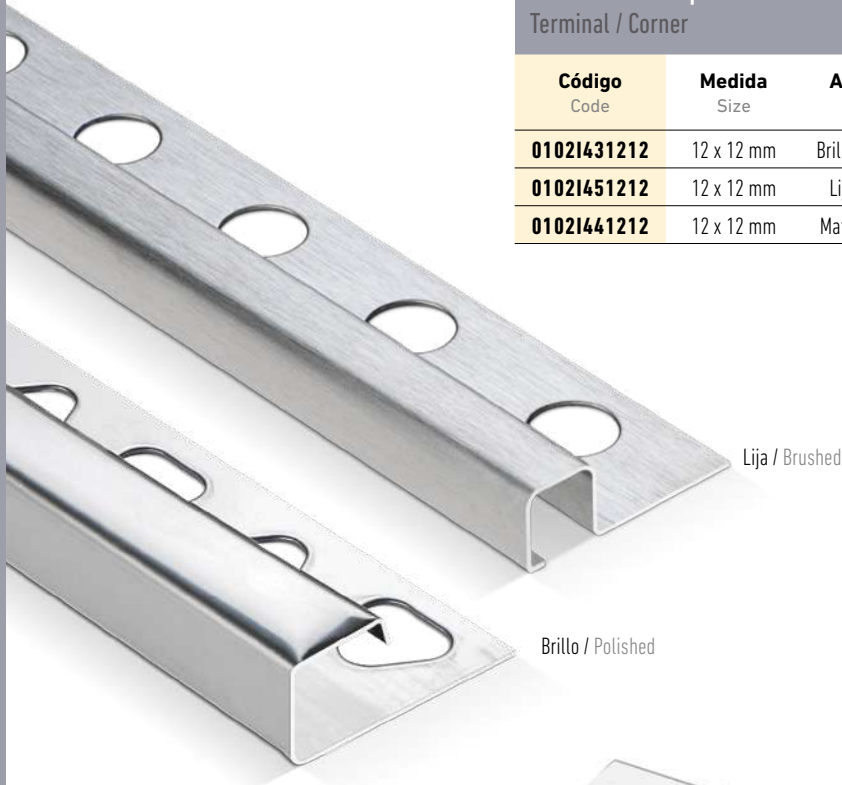

Acabados: Finish:  
Brillo / Lija Polished / Brushed

■ Listelos **Ultra-Fine**  
Ultra-Fine Profiles

Listelo Acero Inox **ULTRA-FINE**  
Ultra-Fine Profiles

Código Code	Medida Size	Acabado Finish	Longitud Length	Packing Packing
<b>01051430212</b>	3 x 12 mm	Brillo Polished	2,60 m	40 uds./pcs.
<b>01051450212</b>	3 x 12 mm	Lija Brushed	2,60 m	40 uds./pcs.
<b>01051580212</b>	3 x 12 mm	Negro Lija Brushed Black	2,60 m	40 uds./pcs.

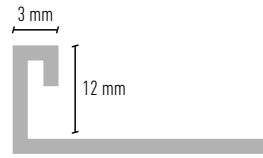

Brillo / Polished



Brillo  
Polished

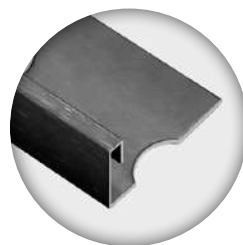

Negro Lija  
Brushed Black



Lija  
Brushed

STAINLESS  
**STEEL**  
AISI 304

■ Guardacanto **Curvo**

Curve Edge Profile

■ Guardacanto **Plano**

Straight Edge Profile

Guardacanto Curvo Acero Inox 12 mm  
Curve Edge Profile Inox 12 mm

Código Code	Medida Size	Acabado Finish	Longitud Length	Packing
<b>01041430012</b>	12 mm	Brillo Polished	2,60 m	20 uds./pcs.
<b>01041450012</b>	12 mm	Lija Brushed	2,60 m	20 uds./pcs.

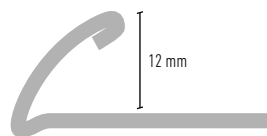

Brillo / Polished

Lija / Brushed

Guardacanto Plano Acero Inox  
Straight Inox Profile

Código Code	Medida Size	Acabado Finish	Longitud Length	Packing
<b>01051430010</b>	10 mm	Brillo Polished	2,60 m	20 uds./pcs.
<b>01051450010</b>	10 mm	Lija Brushed	2,60 m	20 uds./pcs.
<b>01051430012</b>	12 mm	Brillo Polished	2,60 m	20 uds./pcs.
<b>01051450012</b>	12 mm	Lija Brushed	2,60 m	20 uds./pcs.

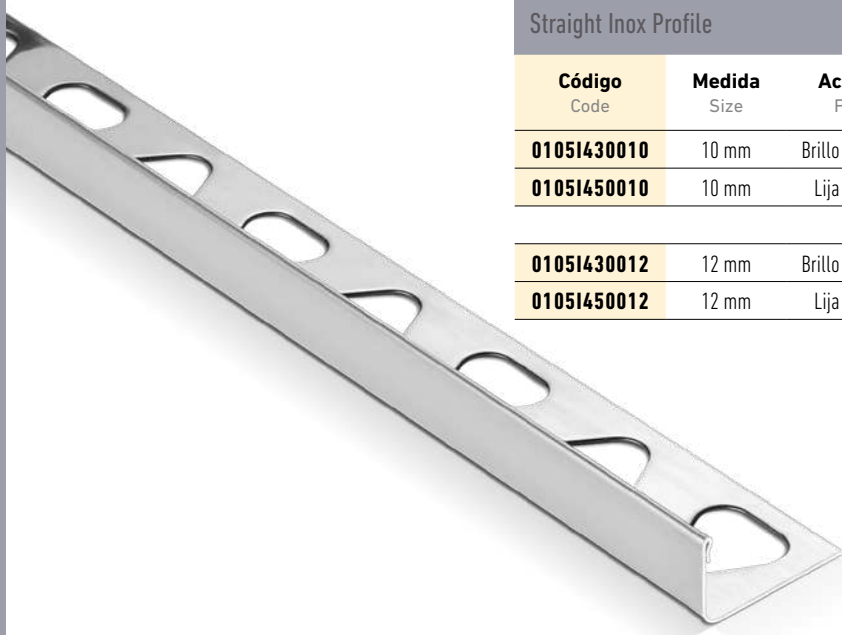
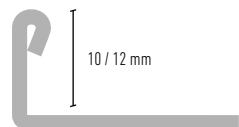

Lija / Brushed

STAINLESS  
**STEEL**  
AISI 304

■ **Listelo U**  
U Profile

■ **Listelo 25 x 12 mm**  
Profile 25 x 12 mm



Listelo Acero Inox U 5 / 10 / 15 / 20 / 25 mm  
U Inox Profile 5 / 10 / 15 / 20 / 25 mm

Brillo Polished	Lija Brushed	Medida Size	Longitud Length	Packing Packing
01031430508	01031450508	5 mm	2,50 m	20 uds./pcs.
01031431008	01031451008	10 mm	2,50 m	20 uds./pcs.
01031431508	01031451508	15 mm	2,50 m	20 uds./pcs.
01031432008	01031452008	20 mm	2,50 m	20 uds./pcs.
01031432508	01031452508	25 mm	2,50 m	20 uds./pcs.

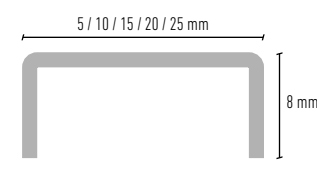

Listelo Acero Inox 25 x 12 mm  
Inox Profile 25 x 12 mm

Código Code	Medida Size	Acabado Finish	Longitud Length	Packing Packing
01011431225	25 x 12 mm	Brillo Polished	2,60 m	15 uds./pcs.
01011451225	25 x 12 mm	Lija Brushed	2,60 m	15 uds./pcs.

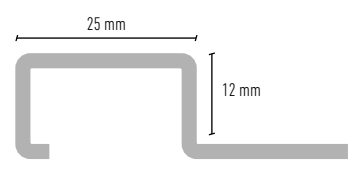

Brillo / Polished



STAINLESS  
STEEL  
AISI 304

■ Ángulo  
Angle

■ Listelo Alfa  
Alpha Profile

Ángulo Acero Inox 15 / 20 / 25 / 30 mm  
Inox Angle 15 / 20 / 25 / 30 mm

Código Code	Medida Size	Acabado Finish	Longitud Length	Packing Packing
01061431515	15 x 15 mm	Brillo Polished	2,60 m	20 uds./pcs.
01061432020	20 x 20 mm	Brillo Polished	2,60 m	20 uds./pcs.
01061432525	25 x 25 mm	Brillo Polished	2,60 m	20 uds./pcs.
01061433030	30 x 30 mm	Brillo Polished	2,60 m	20 uds./pcs.

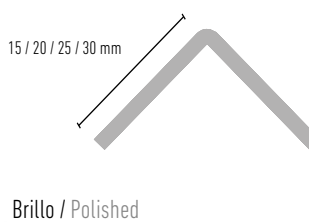
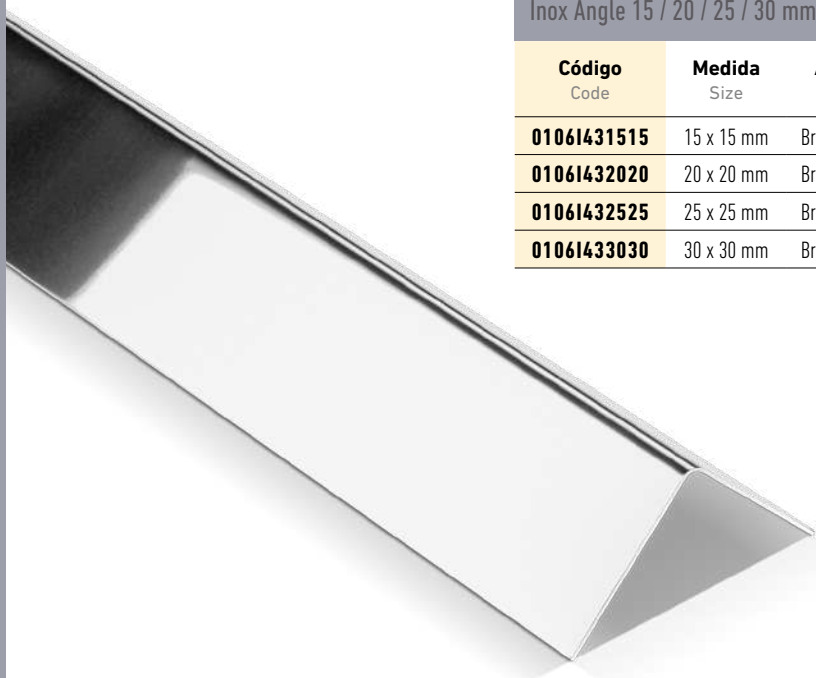

Listelo Alfa Inox 12 x 12 mm  
Alpha Inox Profile 12 x 12 mm

Código Code	Medida Size	Acabado Finish	Longitud Length	Packing Packing
01071431313	12 X 12 mm	Brillo Polished	2,50 m	10 uds./pcs.

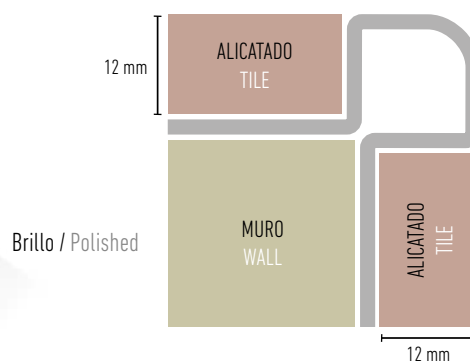
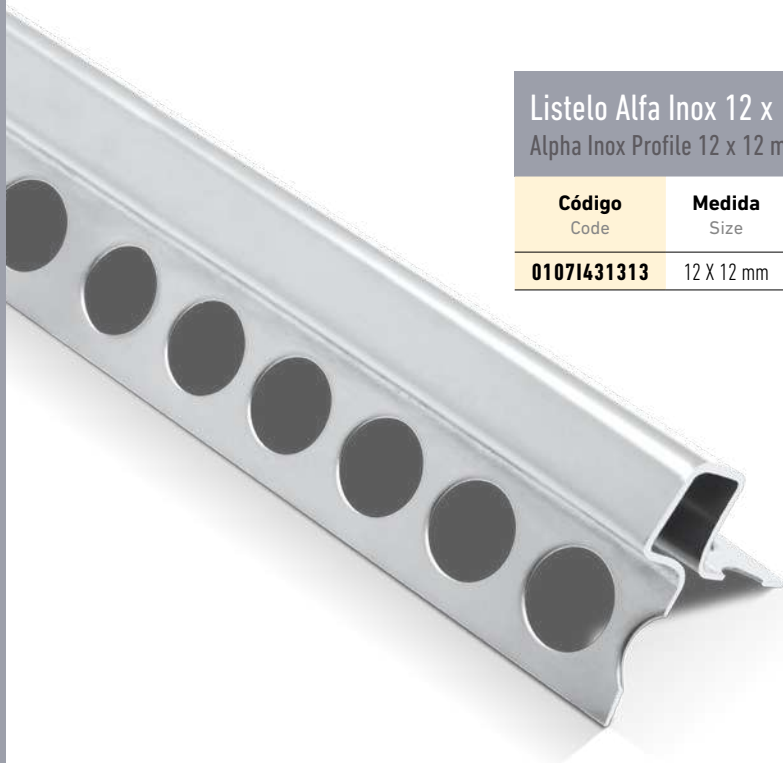



STAINLESS  
**STEEL**  
AISI 304

■ **Listelo T**  
T Profile

■ **Nivel Oblicuo**  
Oblique Profile

**Listelo Acero Inox AISI 304 T**  
T Inox Profile

Código Code	Medida Size	Acabado Finish	Longitud Length	Packing Packing
<b>01091432010</b>	20 mm	Brillo Polished	2,50 m	25 uds./pcs.
<b>01091452010</b>	20 mm	Lija Brushed	2,50 m	25 uds./pcs.



Lija / Brushed

Brillo / Polished

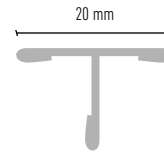

**Nivel Oblicuo Acero Inox AISI 304**  
Oblique Level Inox Profile

Código Code	Medida Size	Acabado Finish	Longitud Length	Packing Packing
<b>01081432012</b>	20 x 12 mm	Brillo Polished	2,50 m	25 uds./pcs.
<b>01081452012</b>	20 x 12 mm	Lija Brushed	2,50 m	25 uds./pcs.

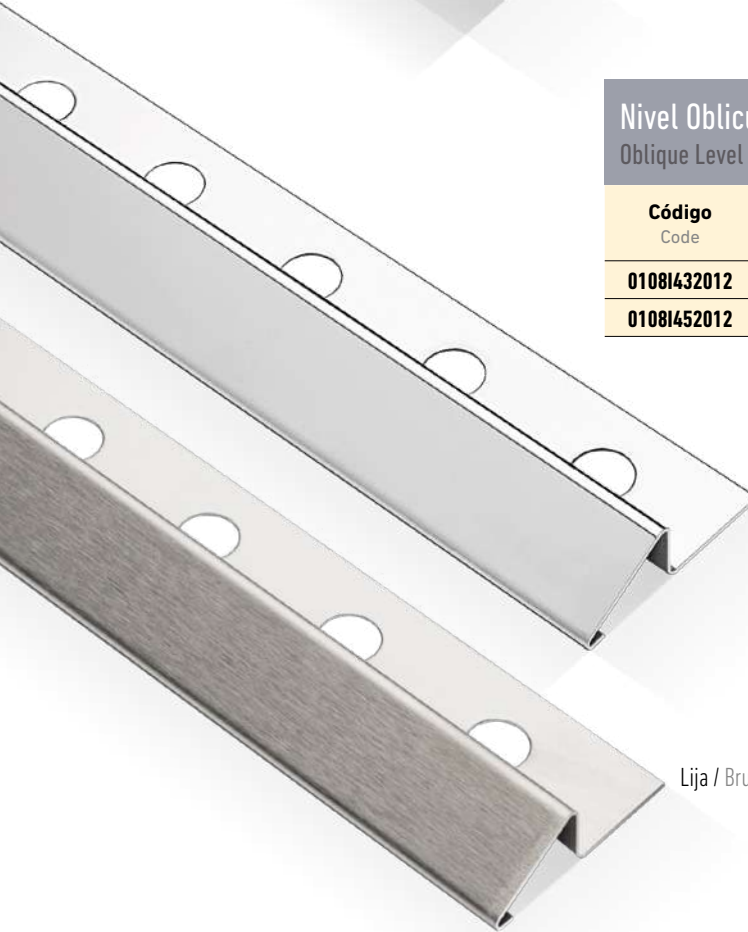

Brillo / Polished

Lija / Brushed

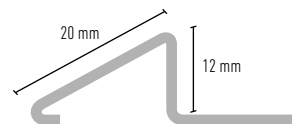



**AL**  
ALUMINIO  
ANODIZADO  
ANODIZED  
ALUMINIUM

# REMATES para el AZULEJO

PROFILES for the TILE

YCR



## Listelos LED

### LED Profiles



Tapa Final / End Cap

#### Listelo LED

##### LED Profile

Código Code	Medida Size	Acabado Finish	Longitud Length	Packing Packing
<b>0901A441212</b>	12,5 x 12,5 mm	Mate Matt	2,60 m	20 uds./pcs.
<b>0901P441212</b>	Recambio Tapa LED Listelo 12,5 mm x 2,60 m Cap Replacement LED Profile 12,5 mm x 2,60 m			
<b>0901P440001</b>	Tapa Final Listelo LED 12,5 x 12,5 mm End Cap LED Profile 12,5 mm x 12,5 mm			

NO INCLUYE TIRA LED / LED STRING NOT INCLUDED

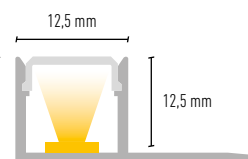

Tapa Final / End Cap

#### Listelo LED U MULTIUSOS

##### Multipurpose U LED Profile

Código Code	Medida Size	Acabado Finish	Longitud Length	Packing Packing
<b>0901A441612</b>	16 x 12 mm	Mate Matt	2,60 m	20 uds./pcs.
<b>0901P441612</b>	Recambio Tapa Listelo LED U 16 mm x 2,60 m Cap Replacement U LED Profile 16 mm x 2,60 m			
<b>0901P440002</b>	Tapa Final Listelo LED U 16 x 12 mm End Cap U LED Profile 16 x 12 mm			

NO INCLUYE TIRA LED / LED STRING NOT INCLUDED

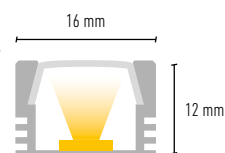

Tapa Final / End Cap

#### Listelo LED TAPAJUNTA

##### Flashing LED Profile

Código Code	Medida Size	Acabado Finish	Longitud Length	Packing Packing
<b>0902A442711</b>	27 x 11 mm	Mate Matt	2,60 m	20 uds./pcs.
<b>0902P442711</b>	Recambio Tapa Listelo LED Tapajunta 27 mm x 2,60 m Cap Replacement Flashing LED Profile 27 mm x 2,60 m			
<b>0902P440001</b>	Tapa Final Listelo LED Tapajunta 27 x 11 mm End Cap Flashing LED Profile 27 x 11 mm			

NO INCLUYE TIRA LED / LED STRING NOT INCLUDED

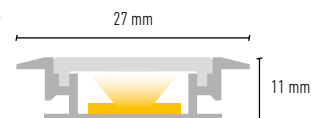



Peldaños LED  
LED Stair Noising



Peldaño LED INTERIOR  
Internal LED Stair Noising

Código Code	Medida Size	Acabado Finish	Longitud Length	Packing Packing
0903A442212	22 x 12 mm	Mate Matt	2,60 m	20 uds./pcs.
0903P440001	Tapa Final PELDAÑO LED INTERIOR 22 mm End Cap Interanal LED Stair Noising			

NO INCLUYE TIRA LED / LED STRING NOT INCLUDED

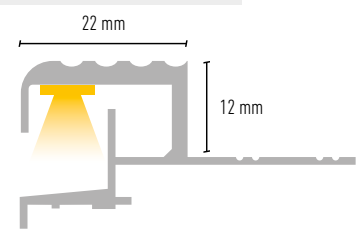

Peldaño LED EXTERIOR  
External LED Stair Noising

Código Code	Medida Size	Acabado Finish	Longitud Length	Packing Packing
0903A444530	45 x 30 mm	Mate Matt	2,60 m	20 uds./pcs.
0903P440002	Tapa Final PELDAÑO LED EXTERIOR 45 mm End Cap External LED Stair Noising			

NO INCLUYE TIRA LED / LED STRING NOT INCLUDED

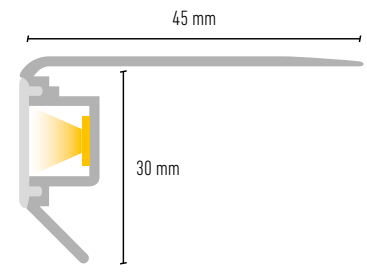



**Listelos Lija**  
Brushed Profiles

Listelos Aluminio Lija 10 x 12 mm  
Brushed Aluminium Profiles 10 x 12 mm

Código Code	Medida Size	Acabado Lija Brushed Finish	Longitud Length	Packing Packing
<b>0201A581012</b>	10 x 12 mm	Negro Black	2,60 m	50 uds./pcs.
<b>0201A591012</b>	10 x 12 mm	Plata Silver	2,60 m	50 uds./pcs.
<b>0201A601012</b>	10 x 12 mm	Champagne Champagne	2,60 m	50 uds./pcs.
<b>0201A611012</b>	10 x 12 mm	Titanio Titanium	2,60 m	50 uds./pcs.
<b>0201A621012</b>	10 x 12 mm	Cobre Copper	2,60 m	50 uds./pcs.

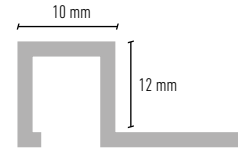
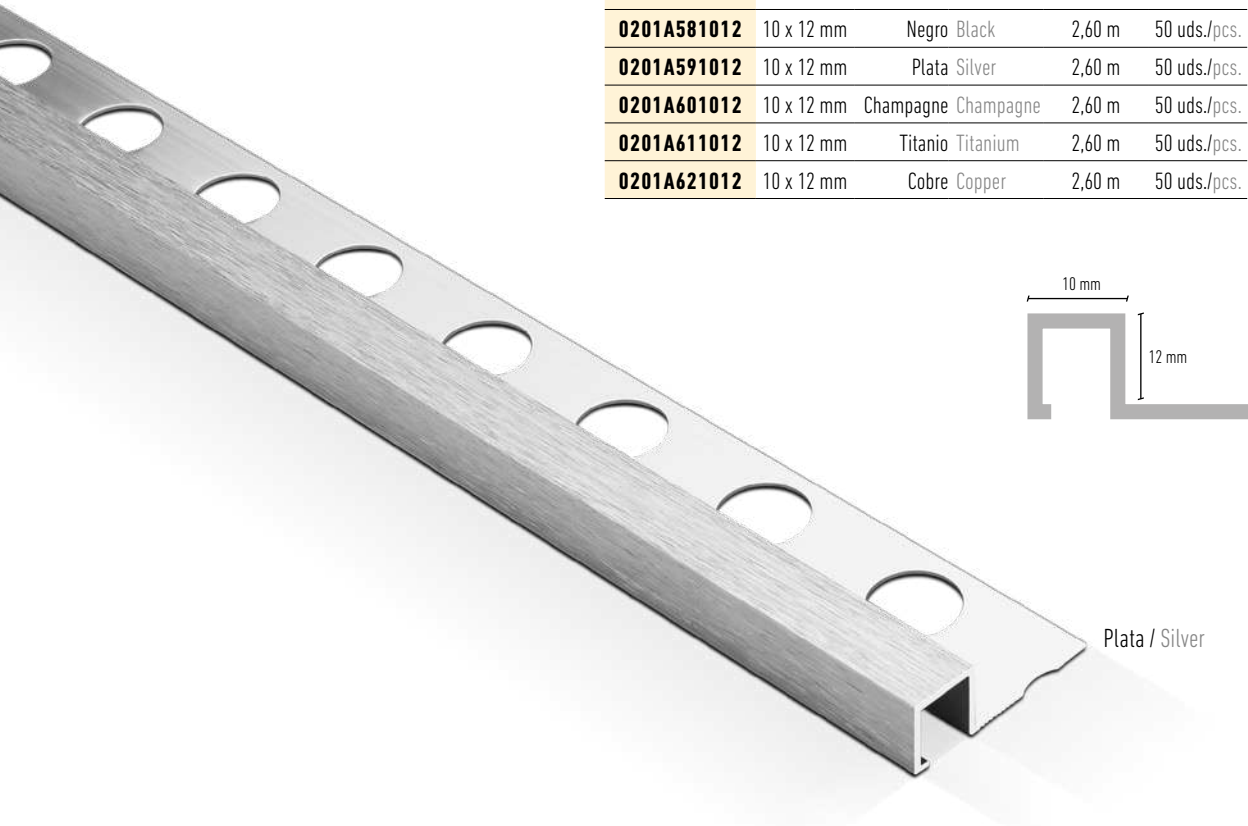



## Listelos Texturizados

### Textured Profiles

#### Listelos Aluminio Texturizado

#### Textured Aluminium Profiles

Código Code	Medida Size	Acabado Finish	Longitud Length	Packing Packing
0201A661012	10 x 12 mm	Antracita Anthracite	2,60 m	50 uds./pcs.
0201A111012	10 x 12 mm	Arena Sand	2,60 m	50 uds./pcs.
0201A571012	10 x 12 mm	Blanco White	2,60 m	50 uds./pcs.
0201A341012	10 x 12 mm	Crema Cream	2,60 m	50 uds./pcs.
0201A511012	10 x 12 mm	Gris Grafito Graphite Grey	2,60 m	50 uds./pcs.
0201A021012	10 x 12 mm	Gris Claro Light Grey	2,60 m	50 uds./pcs.
0201A561012	10 x 12 mm	Marrón Brown	2,60 m	50 uds./pcs.
0201A631012	10 x 12 mm	Musgo Moss	2,60 m	50 uds./pcs.
0201A551012	10 x 12 mm	Negro Black	2,60 m	50 uds./pcs.
0201A651012	10 x 12 mm	Perla Pearl	2,60 m	50 uds./pcs.
0201A671012	10 x 12 mm	Piedra Stone	2,60 m	50 uds./pcs.
0201A641012	10 x 12 mm	Tierra Earth	2,60 m	50 uds./pcs.

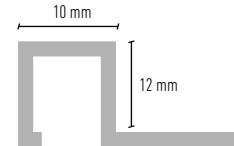
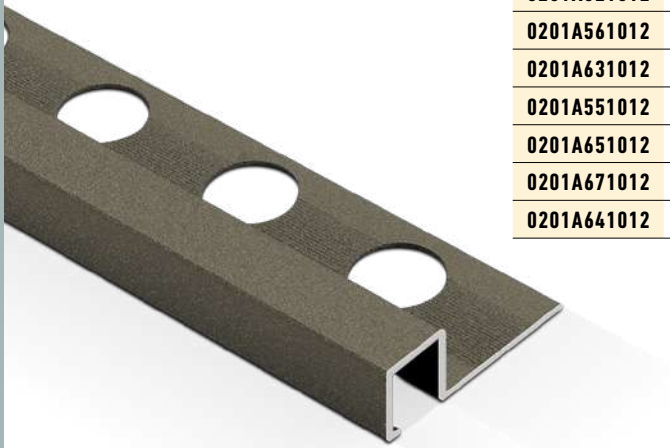

Arena / Sand

Crema / Cream

Tierra / Earth

Perla / Pearl

Piedra / Stone

Musgo / Moss

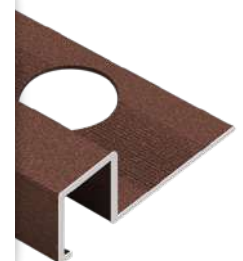
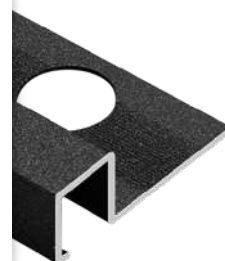
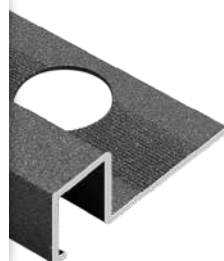
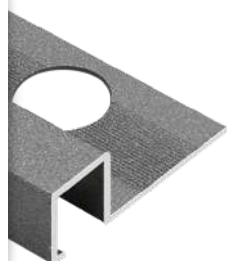
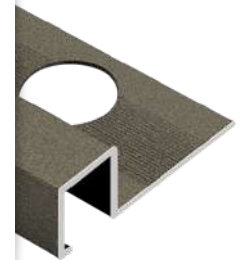

Gris Claro / Light Grey

Antracita / Anthracite

Gris Grafito / Graphite Grey

Negro / Black

Blanco / White

Marrón / Brown



# Guardacantos Planos Texturizados

## Straight Edge Textured Profiles

### Guardacanto Aluminio Plano Texturizado

#### Straight Edge Textured Profiles

Código Code	Medida Size	Acabado Finish	Longitud Length	Packing Packing
0210A660012	12 mm	Antracita Anthracite	2,60 m	50 uds./pcs.
0210A110012	12 mm	Arena Sand	2,60 m	50 uds./pcs.
0210A570012	12 mm	Blanco White	2,60 m	50 uds./pcs.
0210A340012	12 mm	Crema Cream	2,60 m	50 uds./pcs.
0210A510012	12 mm	Gris Grafito Graphite Grey	2,60 m	50 uds./pcs.
0210A020012	12 mm	Gris Claro Light Grey	2,60 m	50 uds./pcs.
0210A560012	12 mm	Marrón Brown	2,60 m	50 uds./pcs.
0210A630012	12 mm	Musgo Moss	2,60 m	50 uds./pcs.
0210A550012	12 mm	Negro Black	2,60 m	50 uds./pcs.
0210A650012	12 mm	Perla Pearl	2,60 m	50 uds./pcs.
0210A670012	12 mm	Piedra Stone	2,60 m	50 uds./pcs.
0210A640012	12 mm	Tierra Earth	2,60 m	50 uds./pcs.

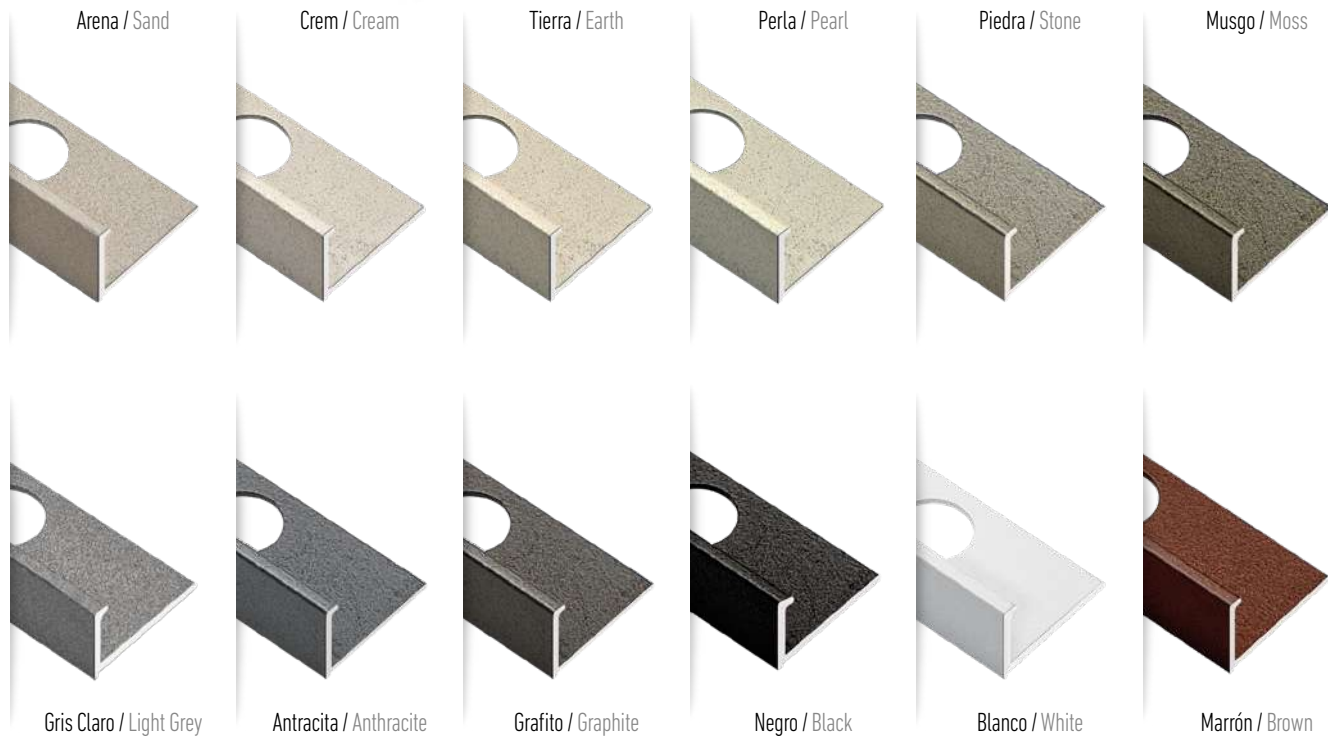
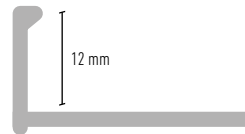



# Listelos Madera

Wood Profiles

## Listelos Aluminio Madera

Wood Aluminium Profiles

Código Code	Medida Size	Acabado Finish	Longitud Length	Packing Packing
0201A681012	10 x 12 mm	Haya Beech	2,60 m	50 uds./pcs.
0201A691012	10 x 12 mm	Fresno Ash	2,60 m	50 uds./pcs.
0201A701012	10 x 12 mm	Roble Oak	2,60 m	50 uds./pcs.
0201A711012	10 x 12 mm	Nogal Woodgrain Walnut	2,60 m	50 uds./pcs.

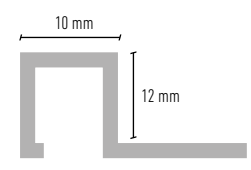





# Guardacantos Planos **Madera**

Straight Edge Wood Profiles

## Guardacanto Aluminio Plano Madera

Straight Edge Wood Profiles

Código Code	Medida Size	Acabado Finish	Longitud Length	Packing Packing
<b>0210A680012</b>	12 mm	Haya Beech	2,60 m	50 uds./pcs.
<b>0210A690012</b>	12 mm	Fresno Ash	2,60 m	50 uds./pcs.
<b>0210A700012</b>	12 mm	Roble Oak	2,60 m	50 uds./pcs.
<b>0210A710012</b>	12 mm	Nogal Woodgrain Walnut	2,60 m	50 uds./pcs.

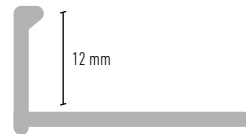



## Listelos 10 x 12 mm

Profiles 10 x 12 mm



### Listelo Aluminio Cromo Brillo 10 x 12 mm

Chrome Polished Aluminium Profile 10 x 12 mm

Código Code	Medida Size	Acabado Finish	Longitud Length	Packing Packing
0201A541012	10 x 12 mm	Cromo Chrome	2,60 m	20 uds./pcs.

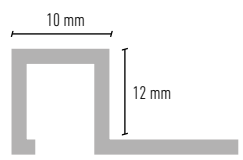

### Listelos Aluminio 10 x 12 mm

Aluminium Profile 10 x 12 mm

Código Code	Medida Size	Acabado Finish	Longitud Length	Packing Packing
0201A011012	10 x 12 mm	Blanco White	2,60 m	50 uds./pcs.
0201A431012	10 x 12 mm	Brillo Polished	2,60 m	50 uds./pcs.
0201A181012	10 x 12 mm	Negro Mate Matt Black	2,60 m	50 uds./pcs.
0201A461012	10 x 12 mm	Bronce Mate Matt Bronze	2,60 m	50 uds./pcs.
0201A441012	10 x 12 mm	Mate Matt	2,60 m	50 uds./pcs.
<b>NEW</b> 0201A471012	10 x 12 mm	Oro Brillo Polished Gold	2,60 m	50 uds./pcs.
<b>NEW</b> 0201A481012	10 x 12 mm	Oro Mate Matt Gold	2,60 m	50 uds./pcs.

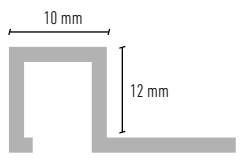

Acabados:  
Brillo / Mate / Blanco  
Finish:  
Polished / Matt / White

### Terminal / Esquina 10 x 12 mm

Terminal / Corner 10 x 12 mm

Código Code	Medida Size	Acabado Finish	Packing Packing
0202A011012	10 x 12 mm	Blanco White	5 uds./pcs.
0202A431012	10 x 12 mm	Brillo Polished	5 uds./pcs.
0202A441012	10 x 12 mm	Mate Matt	5 uds./pcs.





# Listelos Cuadrados

## Square Profiles

### Listelos Cuadrados Aluminio

#### Aluminium Square Profiles

Código Code	Medida Size	Acabado Finish	Longitud Length	Packing Packing
<b>0201A430808</b>	8 x 8 mm	Brillo Polished	2,60 m	50 uds./pcs.
<b>0201A440808</b>	8 x 8 mm	Mate Matt	2,60 m	50 uds./pcs.
<b>0201A431010</b>	10 x 10 mm	Brillo Polished	2,60 m	50 uds./pcs.
<b>0201A441010</b>	10 x 10 mm	Mate Matt	2,60 m	50 uds./pcs.
<b>0201A431212</b>	12 x 12 mm	Brillo Polished	2,60 m	50 uds./pcs.
<b>0201A441212</b>	12 x 12 mm	Mate Matt	2,60 m	50 uds./pcs.
<b>0201A431515</b>	15 x 15 mm	Brillo Polished	2,60 m	50 uds./pcs.
<b>0201A441515</b>	15 x 15 mm	Mate Matt	2,60 m	50 uds./pcs.

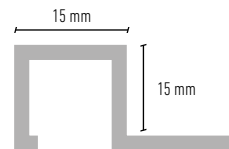
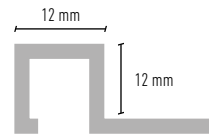
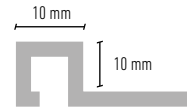
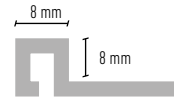
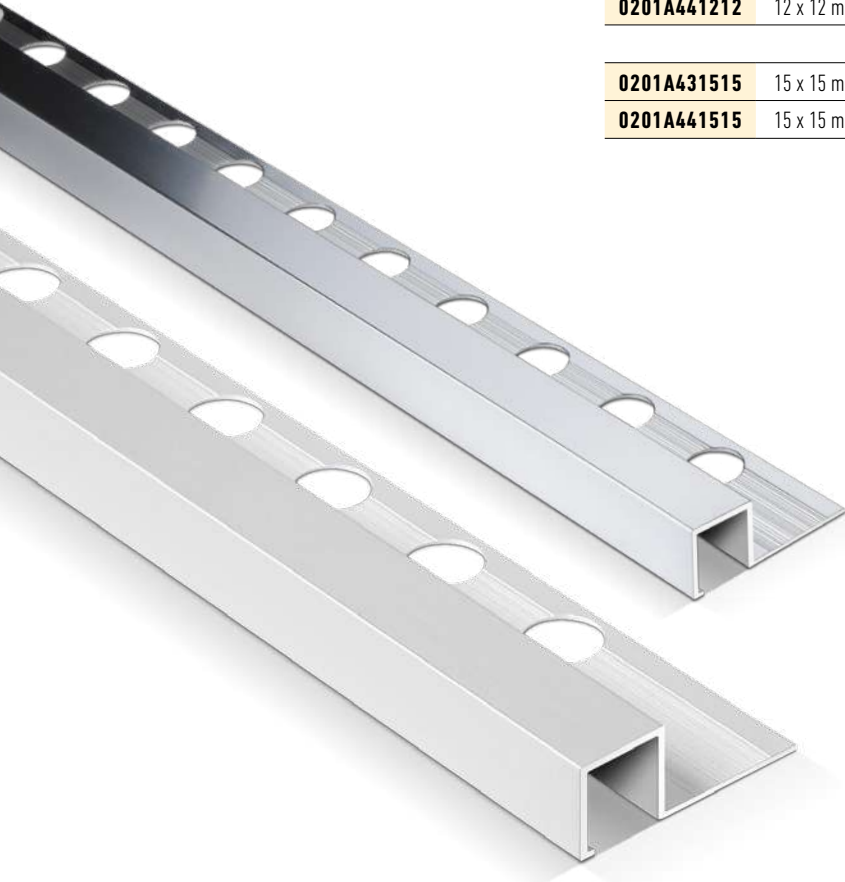



# Guardacantos **Curvos**

## Curve Edge Profiles

### Guardacanto Aluminio Curvo

#### Curve Edge Aluminium Profile

Código Code	Medida Size	Acabado Finish	Longitud Length	Packing Packing
<b>0209A440008</b>	8 mm	Mate Matt	2,60 m	50 uds./pcs.
<b>0209A430008</b>	8 mm	Brillo Polished	2,60 m	50 uds./pcs.
<b>0209A430010</b>	10 mm	Brillo Polished	2,60 m	50 uds./pcs.
<b>0209A010010</b>	10 mm	Blanco White	2,60 m	50 uds./pcs.
<b>0209A440010</b>	10 mm	Mate Matt	2,60 m	50 uds./pcs.
<b>0209A430012</b>	12 mm	Brillo Polished	2,60 m	50 uds./pcs.
<b>0209A010012</b>	12 mm	Blanco White	2,60 m	50 uds./pcs.
<b>0209A440012</b>	12 mm	Mate Matt	2,60 m	50 uds./pcs.
<b>0209A180012</b>	12 mm	Negro Black	2,60 m	50 uds./pcs.
<b>0209A460012</b>	12 mm	Bronce Bronze	2,60 m	50 uds./pcs.

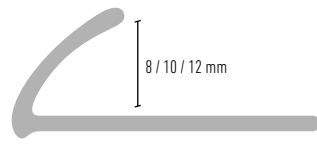

Brillo / Polished

Blanco / White

Negro / Black

Mate / Matt

Bronce / Bronze

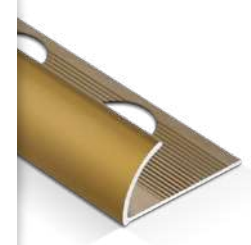
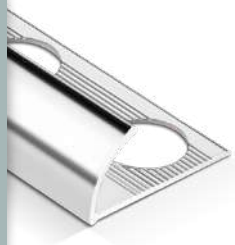

# Guardacantos Planos

## Straight Edge Profiles

### Guardacanto Aluminio Plano

#### Straight Edge Aluminium Profiles

Código Code	Medida Size	Acabado Finish	Longitud Length	Packing Packing
0210A430008	8 mm	Brillo Polished	2,60 m	50 uds./pcs.
0210A440008	8 mm	Mate Matt	2,60 m	50 uds./pcs.
0210A010008	8 mm	Blanco White	2,60 m	50 uds./pcs.
0210A010010	10 mm	Blanco White	2,60 m	50 uds./pcs.
0210A430010	10 mm	Brillo Polished	2,60 m	50 uds./pcs.
0210A440010	10 mm	Mate Matt	2,60 m	50 uds./pcs.
0210A010012	12 mm	Blanco White	2,60 m	50 uds./pcs.
0210A430012	12 mm	Brillo Polished	2,60 m	50 uds./pcs.
0210A440012	12 mm	Mate Matt	2,60 m	50 uds./pcs.
0210A180012	12 mm	Negro Black	2,60 m	50 uds./pcs.
0210A460012	12 mm	Bronce Bronze	2,60 m	50 uds./pcs.
<b>NEW</b> 0210A470012	12 mm	Oro Brillo Polished Gold	2,60 m	50 uds./pcs.
<b>NEW</b> 0210A480012	12 mm	Oro Mate Matt Gold	2,60 m	50 uds./pcs.
0210A430015	15 mm	Brillo Polished	2,60 m	50 uds./pcs.
0210A440015	15 mm	Mate Matt	2,60 m	50 uds./pcs.

**ACABADOS BLANCO O NEGRO EN H.15 BAJO PRESUPUESTO**  
WHITE OR BLACK FINISH FOR H.15 UPON REQUEST

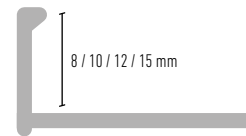

Brillo / Polished

Negro / Black

Mate / Matt

Bronce / Bronze

Blanco / White

Oro Mate / Matt Gold

Oro Brillo / Polished Gold





## Listelos **Canto Romo** 12 x 12 mm

Round Edge Profiles 12 x 12 mm

### Listelo Aluminio 12 x 12 mm **CANTO ROMO**

Round Edge Aluminium Profile 12 x 12 mm

Código Code	Medida Size	Acabado Finish	Longitud Length	Packing Packing
<b>0203A011212</b>	12 x 12 mm	Blanco White	2,60 m	50 uds./pcs.
<b>0203A431212</b>	12 x 12 mm	Brillo Polished	2,60 m	50 uds./pcs.
<b>0203A441212</b>	12 x 12 mm	Mate Matt	2,60 m	50 uds./pcs.

### Terminal / Esquina 12 x 12 mm **CANTO ROMO**

Terminal / Corner 12 x 12 mm Round Edge

Código Code	Medida Size	Acabado Finish	Longitud Length	Packing Packing
<b>0204A011212</b>	12 x 12 mm	Blanco White	Terminal	5 uds./pcs.
<b>0204A431212</b>	12 x 12 mm	Brillo Polished	Terminal	5 uds./pcs.
<b>0204A441212</b>	12 x 12 mm	Mate Matt	Terminal	5 uds./pcs.

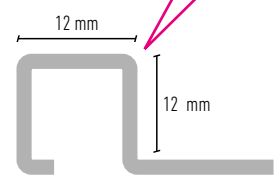
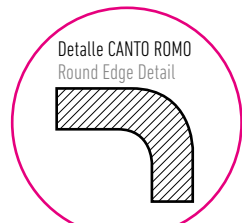

TERMINAL Acabados:  
Brillo / Mate / Blanco  
Finish TERMINAL:  
Polished / Matt / White



■ Listelos **Canto Romo** 25 x 12 mm  
Round Edge Profiles 25 x 12 mm

Listelo Aluminio 25 x 12 mm **CANTO ROMO**  
Round Edge Aluminium Profile 25 x 12 mm

Código Code	Medida Size	Acabado Finish	Longitud Length	Packing Packing
<b>0203A432512</b>	25 x 12 mm	Brillo Polished	2,60 m	50 uds./pcs.
<b>0203A442512</b>	25 x 12 mm	Mate Matt	2,60 m	50 uds./pcs.

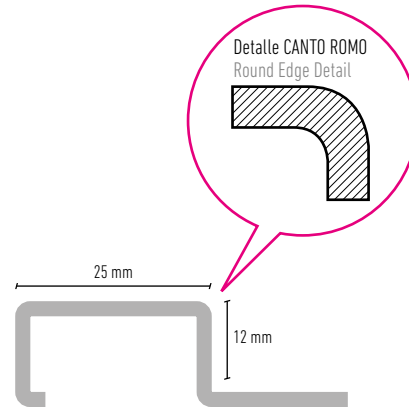



■ Listelos 5 x 12 mm  
 Profiles 5 x 12 mm

Listelo Aluminio 5 x 12 mm  
 Aluminium Profile 5 x 12 mm

Código Code	Medida Size	Acabado Finish	Longitud Length	Packing Packing
0201A430512	5 x 12 mm	Brillo Polished	2,60 m	50 uds./pcs.
0201A440512	5 x 12 mm	Mate Matt	2,60 m	50 uds./pcs.

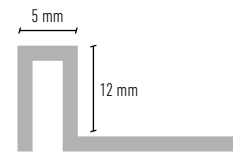



YCR



## Listelos Slim

Slim Profiles

## Guardacantos Slim

Slim Curve Edge Profile

### Listelo Aluminio Slim 4,5 mm

Slim Aluminium Profile 4,5 mm

Código Code	Medida Size	Acabado Finish	Longitud Length	Packing Packing
<b>0206A435545</b>	5,5 x 4,5 mm	Brillo Polished	2,50 m	50 uds./pcs.
<b>0206A445545</b>	5,5 x 4,5 mm	Mate Matt	2,50 m	50 uds./pcs.

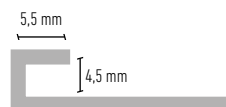

### Guardacanto Aluminio Slim 4,5 mm

Slim Aluminium Curve Edge Profile 4,5 mm

Código Code	Medida Size	Acabado Finish	Longitud Length	Packing Packing
<b>0207A430045</b>	4,5 mm	Brillo Polished	2,50 m	50 uds./pcs.
<b>0207A440045</b>	4,5 mm	Mate Matt	2,50 m	50 uds./pcs.





# YCR

## Ángulos

Angles

## Guardacantos Flecha

Arrow Profile

### Ángulo Aluminio 12,5 x 12,5 / 25 x 25 mm

Aluminium Angle 12,5 x 12,5 / 25 x 25 mm

Código Code	Medida Size	Acabado Finish	Longitud Length	Packing Packing
<b>0208A011212</b>	12,5 x 12,5 mm	Blanco White	2,60 m	50 uds./pcs.
<b>0208A431212</b>	12,5 x 12,5 mm	Brillo Polished	2,60 m	50 uds./pcs.
<b>0208A441212</b>	12,5 x 12,5 mm	Mate Matt	2,60 m	50 uds./pcs.
<b>0208A012525</b>	25 x 25 mm	Blanco White	2,60 m	25 uds./pcs.
<b>0208A432525</b>	25 x 25 mm	Brillo Polished	2,60 m	25 uds./pcs.
<b>0208A442525</b>	25 x 25 mm	Mate Matt	2,60 m	25 uds./pcs.

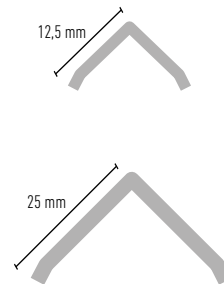

### Guardacanto Aluminio Flecha 13 x 10 mm

Arrow Aluminium Profile 13 x 10 mm

Código Code	Medida Size	Acabado Finish	Longitud Length	Packing Packing
<b>0211A011310</b>	13 x 10 mm	Blanco White	2,60 m	50 uds./pcs.
<b>0211A431310</b>	13 x 10 mm	Brillo Polished	2,60 m	50 uds./pcs.
<b>0211A441310</b>	13 x 10 mm	Mate Matt	2,60 m	50 uds./pcs.

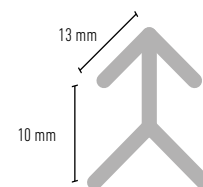

YCR



## Guardacantos **Chañlán**

Chamfer Edge Profile

## Guardacantos **Cruz**

Cross Profile

### Guardacanto Aluminio Chaflan 45° / 10 mm

Chamfer Edge Aluminium Profile 45° / 10 mm

Código Code	Medida Size	Acabado Finish	Longitud Length	Packing Packing
<b>0212A010010</b>	10 mm	Blanco White	2,50 m	50 uds./pcs.
<b>0212A430010</b>	10 mm	Brillo Polished	2,50 m	50 uds./pcs.
<b>0212A440010</b>	10 mm	Mate Matt	2,50 m	50 uds./pcs.

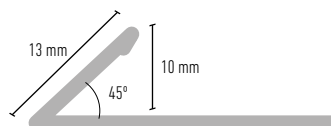

### Guardacanto Aluminio Cruz 10 / 12 mm

Cross Aluminium Profile 10 / 12 mm

Código Code	Medida Size	Acabado Finish	Longitud Length	Packing Packing
<b>0213A431012</b>	10/12 mm	Brillo Polished	2,60 m	50 uds./pcs.
<b>0213A441012</b>	10/12 mm	Mate Matt	2,60 m	50 uds./pcs.

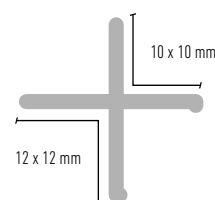



## REMATES para el AZULEJO

PROFILES for the TILE

**Listelos Rústicos**  
Rustics Profiles

**NUEVO ACABADO  
NEW FINISH**  
**NUEVA FÓRMULA  
MEJORADA**  
**NEW IMPROVED FORMULA**

Listelo Rústico 12 x 12 mm  
Rustic Profile 12 x 12 mm

Código Code	Medida Size	Acabado Finish	Longitud Length	Packing Packing
0401F111212	12 x 12 mm	Arena Sand	2,60 m	50 uds./pcs.
0401F081212	12 x 12 mm	Beige Beige	2,60 m	50 uds./pcs.
0401F351212	12 x 12 mm	Champagne Champagne	2,60 m	50 uds./pcs.
0401F101212	12 x 12 mm	Caramelo Caramel	2,60 m	50 uds./pcs.
0401F341212	12 x 12 mm	Crema Cream	2,60 m	50 uds./pcs.
0401F021212	12 x 12 mm	Gris Grey	2,60 m	50 uds./pcs.
0401F091212	12 x 12 mm	Marrón Osc. Dark Brown	2,60 m	50 uds./pcs.
0401F361212	12 x 12 mm	Teja Tile	2,60 m	50 uds./pcs.
0401F181212	12 x 12 mm	Negro Black	2,60 m	50 uds./pcs.

**LIQUIDACIÓN LIQUIDATION**

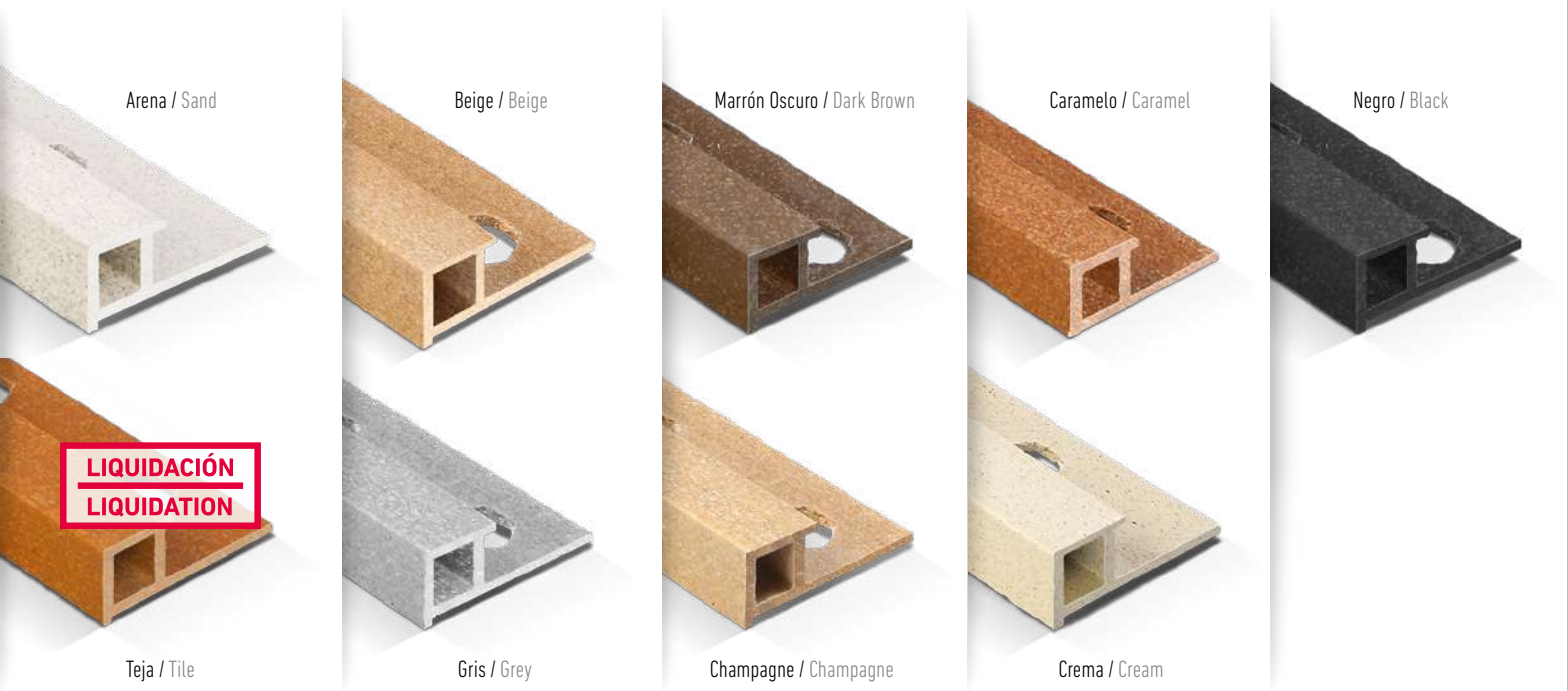
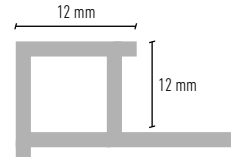

**Guard. Planos Rústicos**  
Straight Edge Rustic Profile

**NUEVO ACABADO  
NEW FINISH**  
**NUEVA FÓRMULA  
MEJORADA**  
**NEW IMPROVED FORMULA**

**Guardacanto Plano Rústico 12 mm**  
Straight Edge Rustic Profile 12 mm

Código Code	Medida Size	Acabado Finish	Longitud Length	Packing Packing
0403F110012	12 mm	Arena Sand	2,60 m	50 uds./pcs.
0403F080012	12 mm	Beige Beige	2,60 m	50 uds./pcs.
0403F350012	12 mm	Champagne Champagne	2,60 m	50 uds./pcs.
0403F100012	12 mm	Caramelo Caramel	2,60 m	50 uds./pcs.
0403F340012	12 mm	Crema Cream	2,60 m	50 uds./pcs.
0403F020012	12 mm	Gris Grey	2,60 m	50 uds./pcs.
0403F090012	12 mm	Marrón Osc. Dark Brown	2,60 m	50 uds./pcs.
0403F360012	12 mm	Teja Tile	2,60 m	50 uds./pcs.
0403F180012	12 mm	Negro Black	2,60 m	50 uds./pcs.

**LIQUIDACIÓN LIQUIDATION**



**LIQUIDACIÓN  
LIQUIDATION**

**Guard. Curvos Rústicos**  
Curve Edge Rustic Profile

Guardacanto Curvo Rústico 12 mm  
Curve Edge Rustic Profile 12 mm

Código Code	Medida Size	Acabado Finish	Longitud Length	Packing Packing
0402F110012	12 mm	Arena Sand	2,60 m	50 uds./pcs.
0402F080012	12 mm	Beige Beige	2,60 m	50 uds./pcs.
0402F350012	12 mm	Champagne Champagne	2,60 m	50 uds./pcs.
0402F100012	12 mm	Caramelo Caramel	2,60 m	50 uds./pcs.
0402F340012	12 mm	Crema Cream	2,60 m	50 uds./pcs.
0402F020012	12 mm	Gris Grey	2,60 m	50 uds./pcs.
0402F090012	12 mm	Marrón Osc. Dark Brown	2,60 m	50 uds./pcs.
0402F360012	12 mm	Teja Tile	2,60 m	50 uds./pcs.
0402F180012	12 mm	Negro Black	2,60 m	50 uds./pcs.

**LIQUIDACIÓN LIQUIDATION**

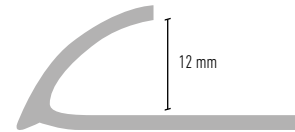

**LIQUIDACIÓN  
LIQUIDATION**



**YCR**

■ Listelos **10 x 10 mm**

Profiles 10 x 10 mm

■ Listelos **12 x 12 mm**

Profiles 12 x 12 mm

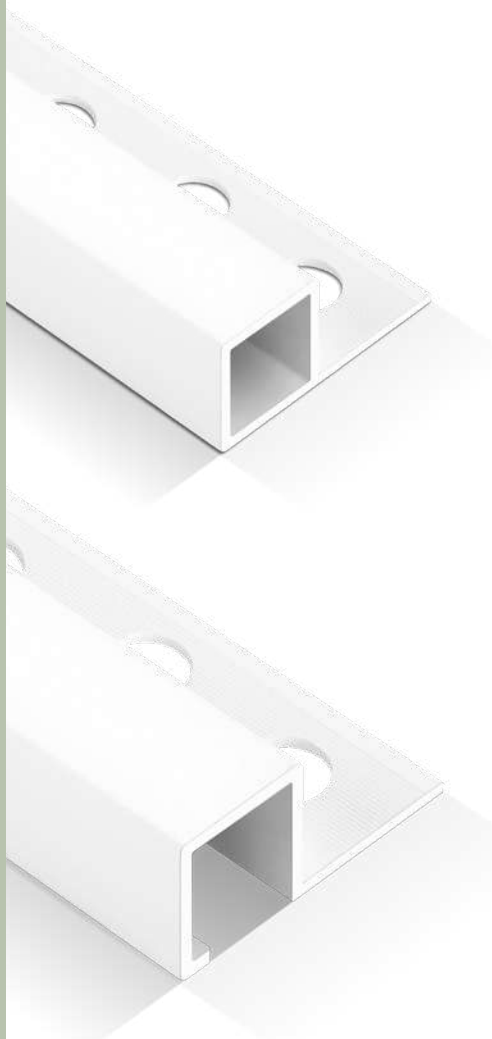

Listelo PVC Cerrado 10 x 10 mm  
Closed PVC Profile 10 x 10 mm

Código Code	Medida Size	Acabado Finish	Longitud Length	Packing Packing
<b>0601P011010</b>	10 x 10 mm	Blanco White	2,60 m	60 uds./pcs.*
<b>0601P081010</b>	10 x 10 mm	Beige Claro Light Beige	2,60 m	60 uds./pcs.
<b>0601P021010</b>	10 x 10 mm	Gris Grey	2,60 m	60 uds./pcs.

LIQUIDACIÓN LIQUIDATION

LIQUIDACIÓN LIQUIDATION

\*CAJAS INDIVISIBLES / \*INDIVISIBLE PACKING

Listelo PVC Abierto 12 x 12 mm  
Opened PVC Profile 12 x 12 mm

Código Code	Medida Size	Acabado Finish	Longitud Length	Packing Packing
<b>0601P011212</b>	12 x 12 mm	Blanco Brillo Bright White	2,60 m	50 uds./pcs.*
<b>0601P081212</b>	12 x 12 mm	Beige Claro Light Beige	2,60 m	50 uds./pcs.
<b>0601P021212</b>	12 x 12 mm	Gris Grey	2,60 m	50 uds./pcs.
<b>0601P061212</b>	12 x 12 mm	Marfil Ivory	2,60 m	50 uds./pcs.
<b>0601P181212</b>	12 x 12 mm	Negro Black	2,60 m	50 uds./pcs.
<b>0601P511212</b>	12 x 12 mm	Gris Grafito Graphite Grey	2,60 m	50 uds./pcs.

\*CAJAS INDIVISIBLES / \*INDIVISIBLE PACKING

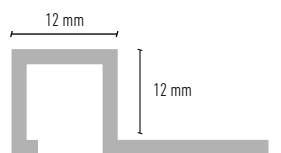
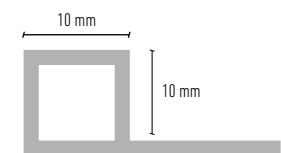





# Guardacantos **Curvos**

## Curve Edge Profiles

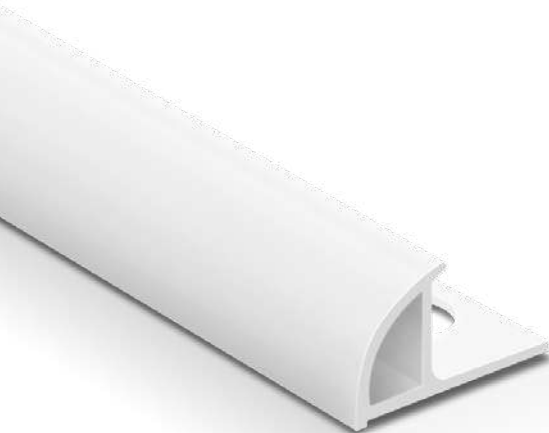

Guardacantos Curvos PVC 8,5 / 10,5 / 11,5 mm  
Curve Edge PVC Profiles 8,5 / 10,5 / 11,5 mm

Código Code	Medida Size	Acabado Finish	Longitud Length	Packing Packing
<b>0604P010085</b>	8,5 mm	Blanco Brillo Bright White	2,60 m	100 uds./pcs.*
<b>0604P010105</b>	10,5 mm	Blanco Brillo Bright White	2,60 m	100 uds./pcs.*
<b>0604P011115</b>	11,5 mm	Blanco Brillo Bright White	2,60 m	100 uds./pcs.*
<b>*CAJAS INDIVISIBLES / *INDIVISIBLE PACKING</b>				
<b>0604P020115</b>	11,5 mm	Gris Claro Light Grey	2,60 m	100 uds./pcs.
<b>0604P030115</b>	11,5 mm	Gris Oscuro Dark Grey	2,60 m	100 uds./pcs.
<b>0604P040115</b>	11,5 mm	Gris Perla Pearl Grey	2,60 m	100 uds./pcs.
<b>0604P050115</b>	11,5 mm	Gris Marengo Chacoral Grey	2,60 m	100 uds./pcs.
<b>0604P060115</b>	11,5 mm	Marfil Ivory	2,60 m	100 uds./pcs.
<b>0604P070115</b>	11,5 mm	Beige Oscuro Dark Beige	2,60 m	100 uds./pcs.
<b>0604P080115</b>	11,5 mm	Beige Claro Light Beige	2,60 m	100 uds./pcs.
<b>0604P090115</b>	11,5 mm	Marrón Brown	2,60 m	100 uds./pcs.
<b>0604P100115</b>	11,5 mm	Caramelo Caramel	2,60 m	100 uds./pcs.
<b>0604P110115</b>	11,5 mm	Arena Sand	2,60 m	100 uds./pcs.
<b>0604P180115</b>	11,5 mm	Negro Black	2,60 m	100 uds./pcs.
<b>*UNIDADES SUeltas INCREMENTO DEL 30% / *SINGLE UNITS 30% INCREASE</b>				

LIQUIDACIÓN LIQUIDATION

LIQUIDACIÓN LIQUIDATION

LIQUIDACIÓN LIQUIDATION

LIQUIDACIÓN LIQUIDATION

LIQUIDACIÓN LIQUIDATION

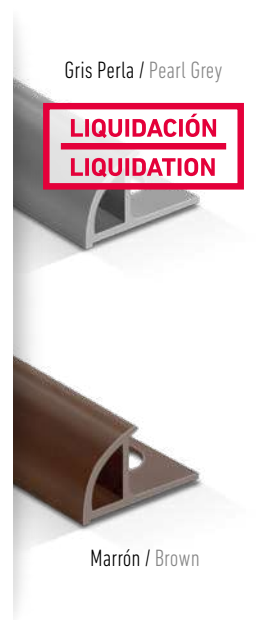



## Guardacantos Planos

Straight Edge Profiles

## Ángulos

Angles

### Guardacanto PVC Plano Straight Edge PVC Profile

Código Code	Medida Size	Acabado Finish	Longitud Length	Packing Packing
<b>0602P010112</b>	12 mm	Blanco Fine Fine White	2,60 m	100 uds./pcs.
<b>0602P060012</b>	12 mm	Marfil Ivory	2,60 m	100 uds./pcs.

UNIDADES SUELTAS INCREMENTO DEL 30% / SINGLE UNITS 30% INCREASE

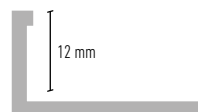

### Ángulo PVC 25 x 25 mm PVC Angle 25 x 25 mm

Código Code	Medida Size	Acabado Finish	Longitud Length	Packing Packing
<b>0607P012525</b>	25 x 25 mm	Blanco Fine Fine White	2,60 m	50 uds./pcs.
<b>0603P062525</b>	25 x 25 mm	Marfil Ivory	2,60 m	50 uds./pcs.

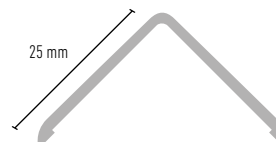



# PERFILES PARA PAVIMENTO

PROFILES  
for  
PAVEMENT

**Peldaño Rústico P6**  
P6 Rustic Stair Noising

**NUEVO ACABADO  
NEW FINISH**  
**NUEVA FÓRMULA  
MEJORADA**  
**NEW IMPROVED FORMULA**

**Peldaño Rústico P6 45 x 12 mm**  
P6 Rustic Stair Noising 45 x 12 mm

Código Code	Medida Size	Acabado Finish	Longitud Length	Packing Packing
0403F114512	45 x 12 mm	Arena Sand	2,50 m	10 uds./pcs.
0403F084512	45 x 12 mm	Beige Beige	2,50 m	10 uds./pcs.
0403F354512	45 x 12 mm	Champagne Champagne	2,50 m	10 uds./pcs.
0403F104512	45 x 12 mm	Caramelo Caramel	2,50 m	10 uds./pcs.
0403F344512	45 x 12 mm	Crema Cream	2,50 m	10 uds./pcs.
0403F024512	45 x 12 mm	Gris Grey	2,50 m	10 uds./pcs.
0403F094512	45 x 12 mm	Marrón Osc. Dark brown	2,50 m	10 uds./pcs.
0403F364512	45 x 12 mm	Teja Tile	2,50 m	10 uds./pcs.
0403F184512	45 x 12 mm	Negro Black	2,50 m	10 uds./pcs.

**LIQUIDACIÓN**

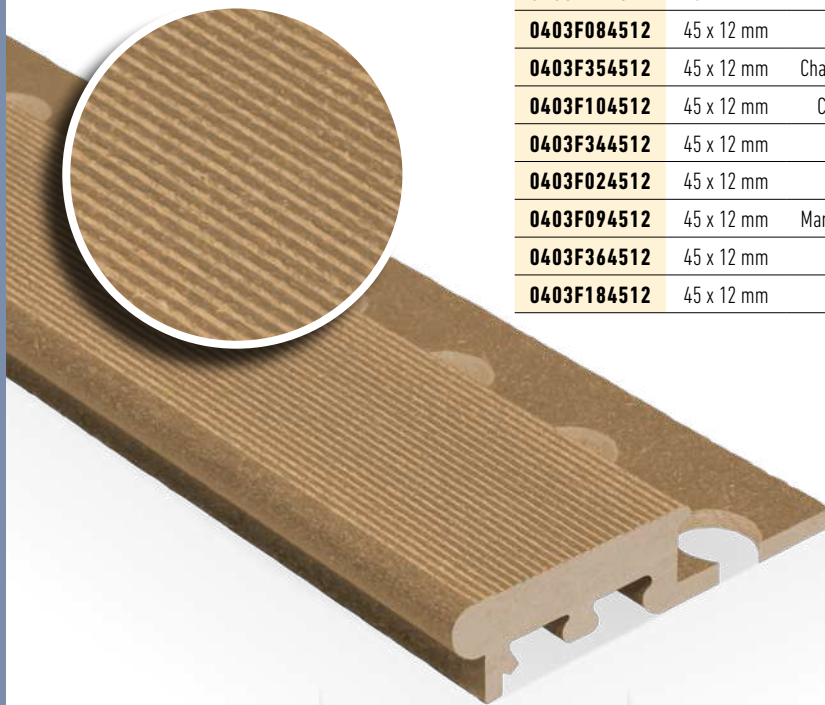
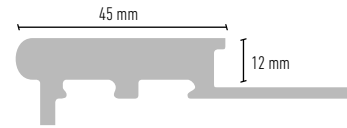



# Peldaño Rústico P7

P7 Rustic Stair Noising

**NUEVO ACABADO  
NEW FINISH**  
**NUEVA FÓRMULA  
MEJORADA**  
**NEW IMPROVED FORMULA**

## Peldaño Rústico P7 25 x 12 mm

P7 Rustic Stair Noising 25 x 12 mm

Código Code	Medida Size	Acabado Finish	Longitud Length	Packing Packing
0404F112512	25 x 12 mm	Arena Sand	2,50 m	10 uds./pcs.
0404F082512	25 x 12 mm	Beige Beige	2,50 m	10 uds./pcs.
0404F102512	25 x 12 mm	Caramelo Caramel	2,50 m	10 uds./pcs.
0404F352512	25 x 12 mm	Champagne Champagne	2,50 m	10 uds./pcs.
0404F342512	25 x 12 mm	Crema Cream	2,50 m	10 uds./pcs.
0404F022512	25 x 12 mm	Gris Grey	2,50 m	10 uds./pcs.
0404F092512	25 x 12 mm	Marrón Osc. Dark brown	2,50 m	10 uds./pcs.
0404F182512	25 x 12 mm	Negro Black	2,50 m	10 uds./pcs.

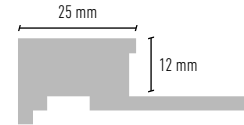
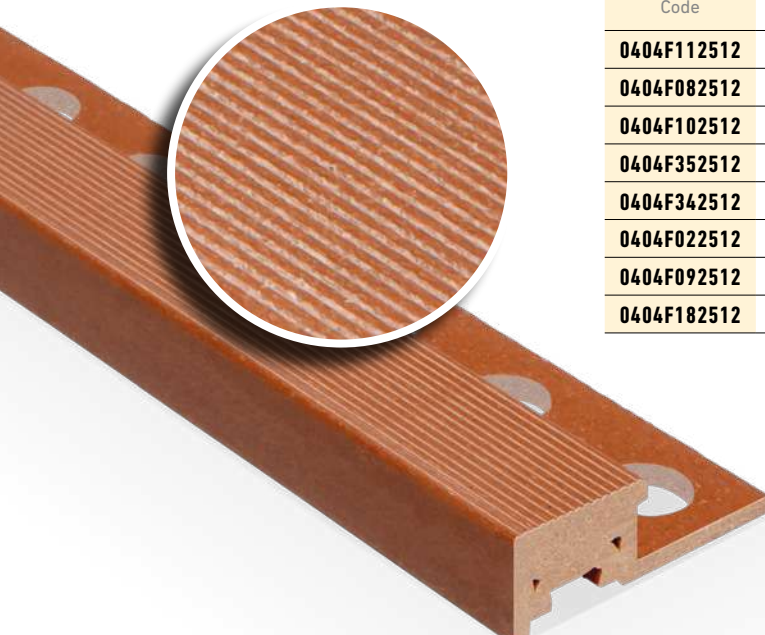



■ Pletina **T** Antideslizante

Antislipping T Plate

■ Pletina Antideslizante

Antislipping Plate

■ Peldaño **P5**

P5 Stair Noising

Pletina **T** Antideslizante Aluminio Mate

Antislipping T Plate Matt Aluminium

Código Code	Medida Size	Acabado Finish	Longitud Length	Packing Packing
<b>0217A440986</b>	9 x 8,6 mm	Plata Mate Matt Silver	2,50 m	50 uds./pcs.

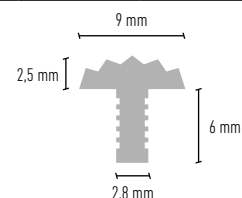

Pletina Antideslizante Aluminio Mate

Antislipping Plate Matt Aluminium

Código Code	Medida Size	Acabado Finish	Longitud Length	Packing Packing
<b>0217A441224</b>	12 x 2,5 mm	Plata Mate Matt Silver	2,50 m	50 uds./pcs.

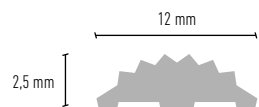

Peldaño **P5** Aluminio Mate / PVC Negro Antideslizante

P5 Stair Noising Matt Aluminium / Antislipping Black PVC

Código Code	Medida Size	Acabado Step Finish	Peldaño Color PVC	Longitud Length	Packing Packing
<b>0219A441712</b>	17 x 12,5 mm	Plata Mate Matt Silver	Negro Black	2,50 m	25 uds./pcs.

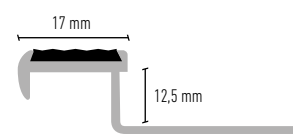

■ **Peldaño P2**  
P2 Stair Noising

■ **Peldaño P1**  
P1 Stair Noising

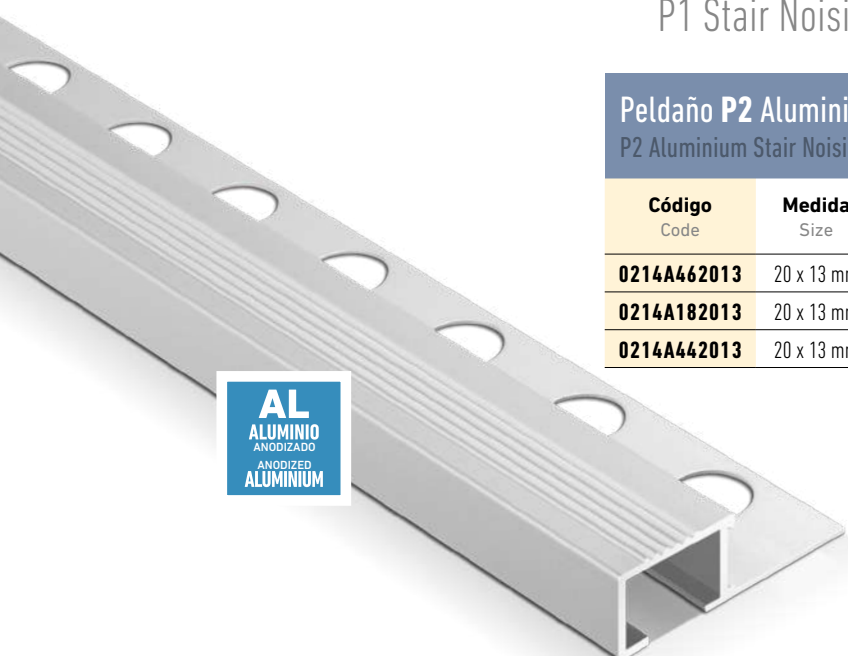

**AL**  
ALUMINIO  
ANODIZADO  
ANODIZED  
ALUMINIUM

**Peldaño P2 Aluminio 20 x 13 mm**  
P2 Aluminium Stair Noising 20 x 13 mm

Código Code	Medida Size	Acabado Finish	Longitud Length	Packing Packing
<b>0214A462013</b>	20 x 13 mm	Bronce / Bronze	2,50 m	25 uds./pcs.
<b>0214A182013</b>	20 x 13 mm	Negro / Black	2,50 m	25 uds./pcs.
<b>0214A442013</b>	20 x 13 mm	Mate / Matt	2,50 m	25 uds./pcs.

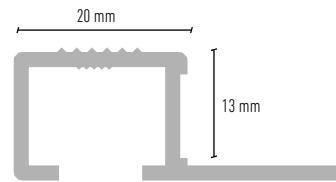

Mate / Matt

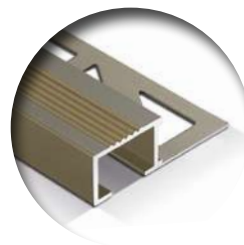

Bronce / Bronze



Negro / Black



**STAINLESS  
STEEL**  
AISI 304

**Peldaño P1 Acero Inox 25 x 12 mm**  
P1 Inox Stair Noising 25 x 12 mm

Código Code	Medida Size	Acabado Finish	Longitud Length	Packing Packing
<b>0113I432512</b>	25 x 12 mm	Brillo / Polished	2,50 m	10 uds./pcs.

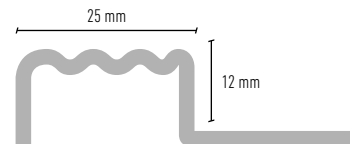



**Peldaño P3**  
P3 Stair Noising

**Peldaño Curvo P3 Aluminio 11 mm**  
P3 Curve Aluminium Stair Noising 11 mm

Código Code	Medida Size	Acabado Finish	Longitud Length	Packing Packing
0215A460011	11 mm	Bronce Mate / Matt Bronze	2,50 m	20 uds./pcs.
0215A180011	11 mm	Negro Mate / Matt Black	2,50 m	20 uds./pcs.
0215A440011	11 mm	Mate / Matt	2,50 m	20 uds./pcs.

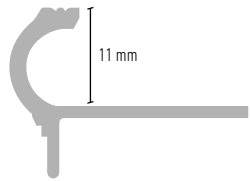

Negro Mate / Matt Black



Mate / Matt

Bronce Mate / Matt Bronze







**Peldaño P4**  
P4 Stair Noising

**Peldaño P4 Aluminio 35 x 25 mm**  
P4 Aluminium Stair Noising 35 x 25 mm

Código Code	Medida Size	Acabado Finish	Longitud Length	Packing Packing
<b>0216A463525</b>	35 x 25 mm	Bronce Bronze	2,50 m	25 uds./pcs.
<b>0216A183525</b>	35 x 25 mm	Negro Black	2,50 m	25 uds./pcs.
<b>0216A443525</b>	35 x 25 mm	Mate Matt	2,50 m	25 uds./pcs.

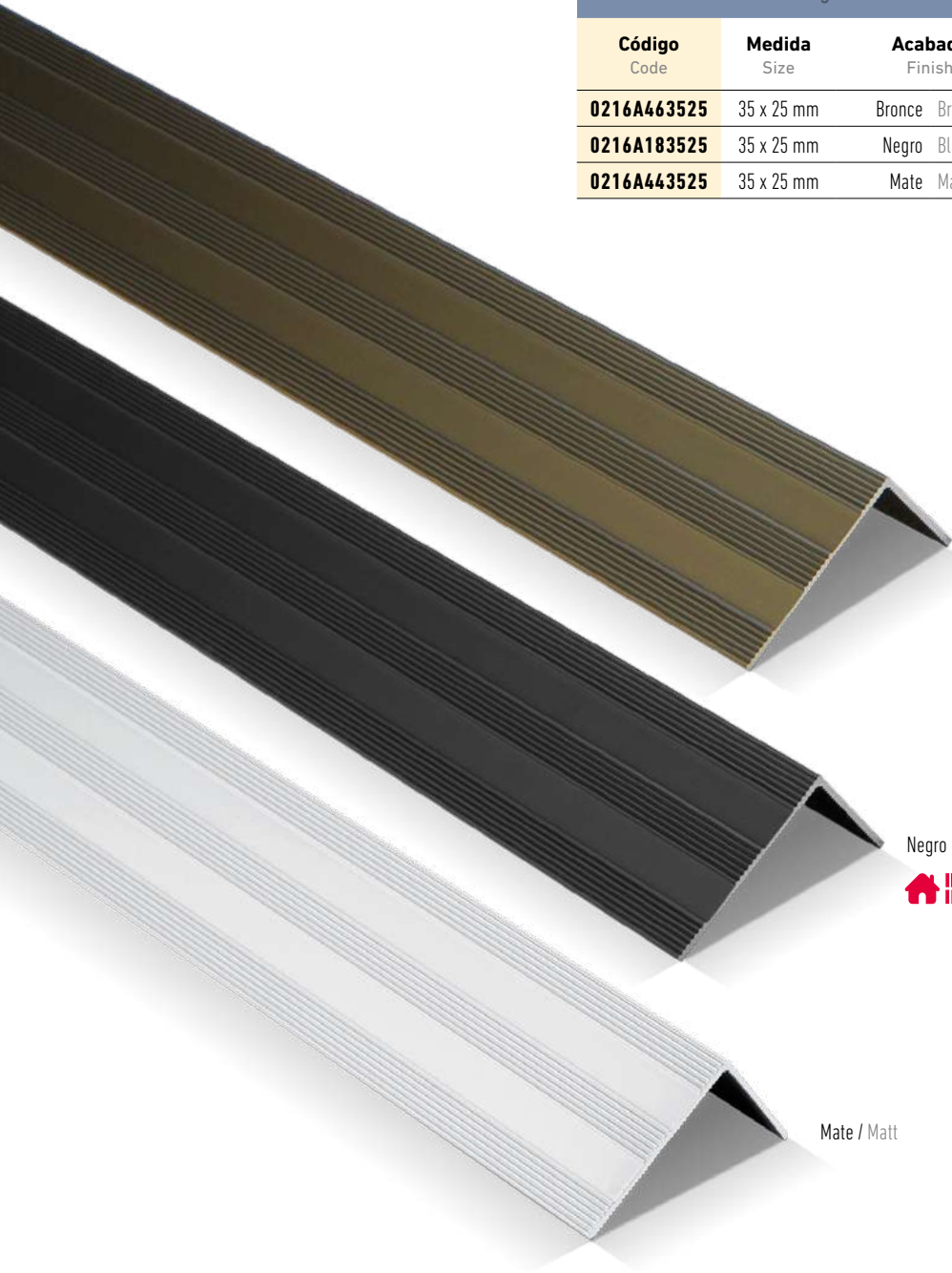
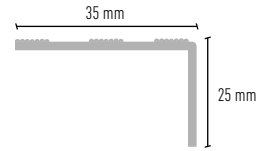

Bronce Mate / Matt Bronze



Negro Mate / Matt Black



Mate / Matt



■ Vierteaguas **V1**

V1 Drip Edge

■ Vierteaguas **V2**

V2 Drip Edge

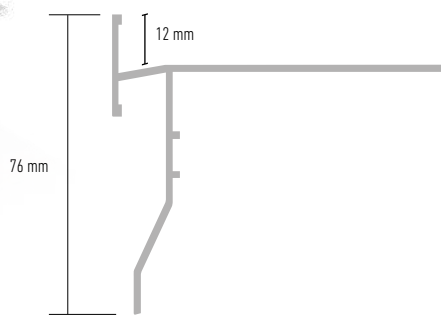

Vierteaguas **V1** Aluminio 12 mm  
Drip Edge Aluminium V1 12 mm

Código Code	Medida Size	Acabado Finish	Longitud Length	Packing Packing
<b>0801A440012</b>	12 mm	Plata Mate Matt Silver	2,50 m	10 uds./pcs.

LACADO EN COLORES RAL BAJO PEDIDO / POWDER-COATED FINISH IN RAL COLOUR UPON REQUEST

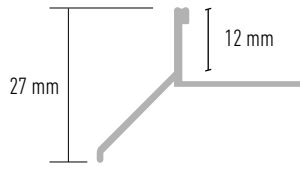

Vierteaguas **V2** Aluminio 12 mm  
Drip Edge Aluminium V2 12 mm

Código Code	Medida Size	Acabado Finish	Longitud Length	Packing Packing
<b>0802A440012</b>	12 mm	Plata Mate Matt Silver	2,50 m	20 uds./pcs.

LACADO EN COLORES RAL BAJO PEDIDO / POWDER-COATED FINISH IN RAL COLOUR UPON REQUEST



## Separadores Pavimento Pavement Spacers

### Listelo Aluminio T 6 / 8 / 10 / 20 / 25 mm T Aluminium Profile 6 / 8 / 10 / 20 / 25 mm

Medida Size	Plata Brillo Polished Silver	Plata Mate Matt Silver	Longitud Length	Packing Packing
6 mm	<b>0205A430006</b>	<b>0205A440006</b>	2,50 m	50 uds./pcs.
8 mm	<b>0205A430008</b>	<b>0205A440008</b>	2,50 m	50 uds./pcs.
10 mm	<b>0205A430010</b>	<b>0205A440010</b>	2,50 m	50 uds./pcs.
20 mm	<b>0205A430020</b>	<b>0205A440020</b>	2,50 m	50 uds./pcs.
25 mm	<b>0205A430025</b>	<b>0205A440025</b>	2,50 m	50 uds./pcs.

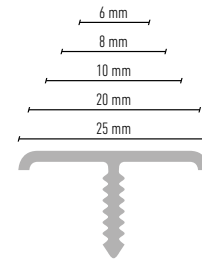

### Separador Aluminio Z Aluminium Spacer Z

Código Code	Medida Size	Acabado Finish	Longitud Length	Packing Packing
<b>0217A441212</b>	12 x 12 mm	Plata Mate Matt Silver	2,50 m	20 uds./pcs.
<b>0217A441215</b>	12 x 15 mm	Plata Mate Matt Silver	2,50 m	20 uds./pcs.

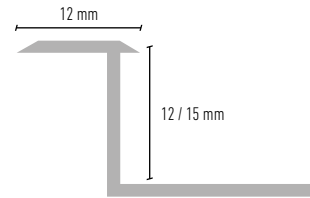

### Tapajuntas Aluminio Aluminium Flashing

Código Code	Medida Size	Acabado Finish	Longitud Length	Packing Packing
<b>0205A443824</b>	38 x 1,5 mm	Mate Matt	2,50 m	25 uds./pcs.

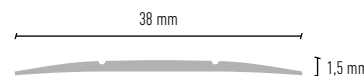



■ Nivel **Magnum**

Magnum Level

■ Nivel **Oblicuo**

Oblique Level

Nivel Aluminio Magnum  
Magnum Aluminium Level



Código Code	Medida Size	Acabado Finish	Longitud Length	Packing Packing
<b>0217A448912</b>	89 x 12 mm	Mate Matt	2,50 m	10 uds./pcs.

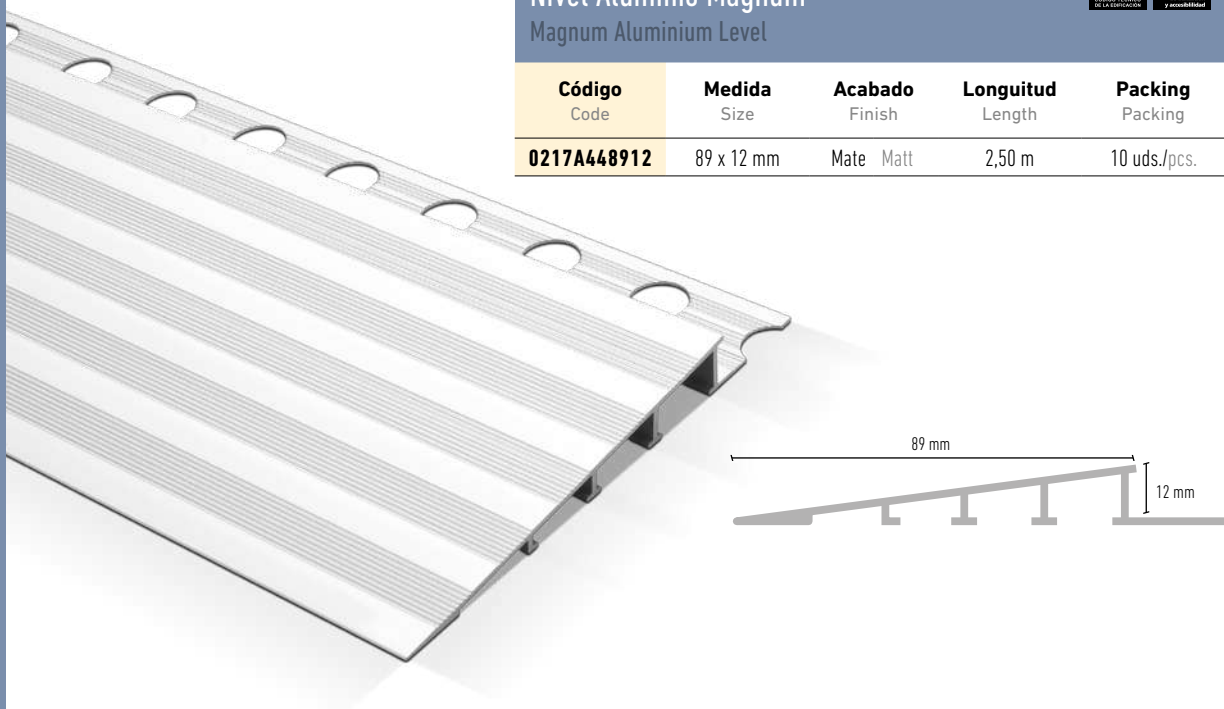

Nivel Oblicuo Aluminio 20 x 10 mm  
Oblique Aluminium Level 20 x 10 mm

Código Code	Medida Size	Acabado Finish	Longitud Length	Packing Packing
<b>0217A482012</b>	20 x 10 mm	Dorado Golden	2,50 m	50 uds./pcs.
<b>0217A442012</b>	20 x 10 mm	Mate Matt	2,50 m	50 uds./pcs.

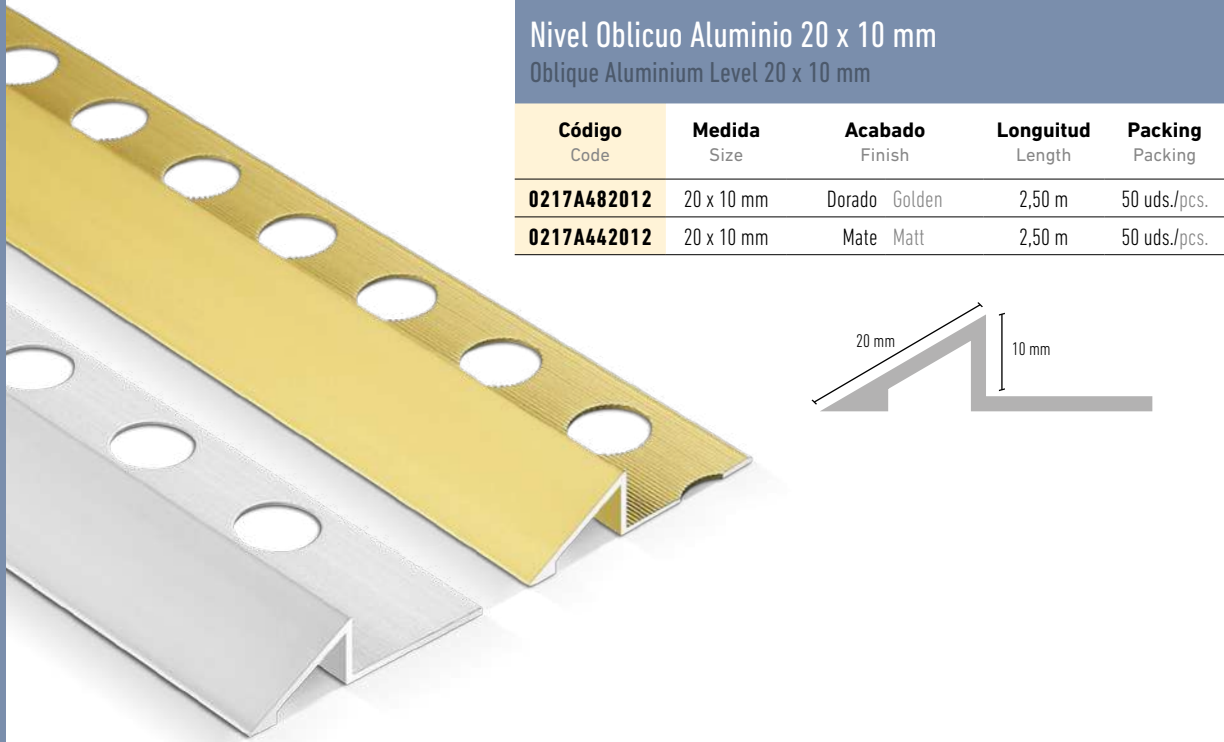



# JUNTAS de DILATACIÓN

EXPANSION  
JOINTS



# Junta Dilatación Reversible JD9

Reverse Expansion Joint JD9

## Junta Dilatación Reversible JD9 Aluminio Mate

Reverse Expansion Joint JD9 Matt Aluminium

Código Code	Medida Size	Acabado Finish	Longitud Length	Packing
0507A445513	55/15 x 13,5 mm	Plata Mate Matt Silver	2,50 m	20 uds./pcs.
JUNTA MONTADA CON GOMA GRIS Y NEGRA / GREY AND BLACK RUBBER INSERTED				



**JD9 VIDEO TUTORIAL**

- INSTALACIÓN
- INSTALLATION

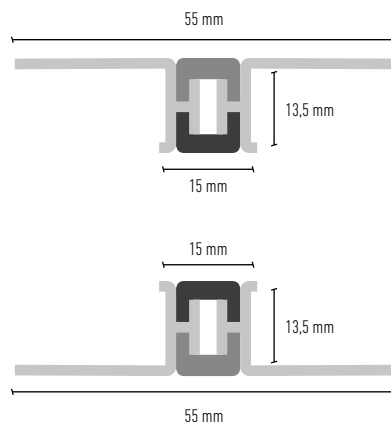

## Recambio JD1/JD9 Junta de Goma

Rubber Replacement JD1/JD9

Medida Size	Marrón Brown	Beige Beige	Marfil Ivory	Longitud Length	Packing
15 mm	0502A090125	0502A080125	0502A060125	2,50 m	25 uds./pcs.

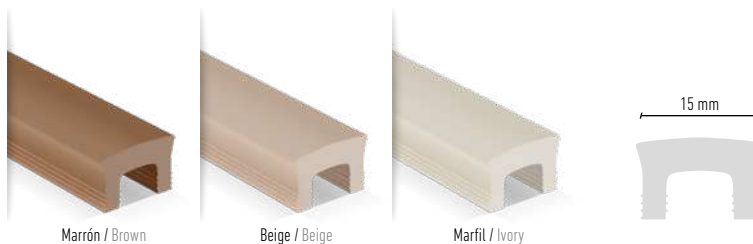



## Junta Dilatación **JD1** Intercambiable

Interchangeable Expansion Joint JD1

## Junta Dilatación **JD3**

JD3 Expansion Joint



### Junta Dilatación Aluminio **JD1** + Junta de Goma

Aluminium Expansion Joint JD1 + Rubber

Código Code	Medida Size	Acabado Finish	Longitud Length	Packing Packing
<b>0501A021512</b>	15 x 12,5 mm	Gris Claro Light Grey	2,50 m	20 uds./pcs.
<b>0501A021515</b>	15 x 15 mm	Gris Claro Light Grey	2,50 m	20 uds./pcs.

**JUNTA MONTADA CON GOMA GRIS CLARO / LIGHT GREY RUBBER INSERTED**

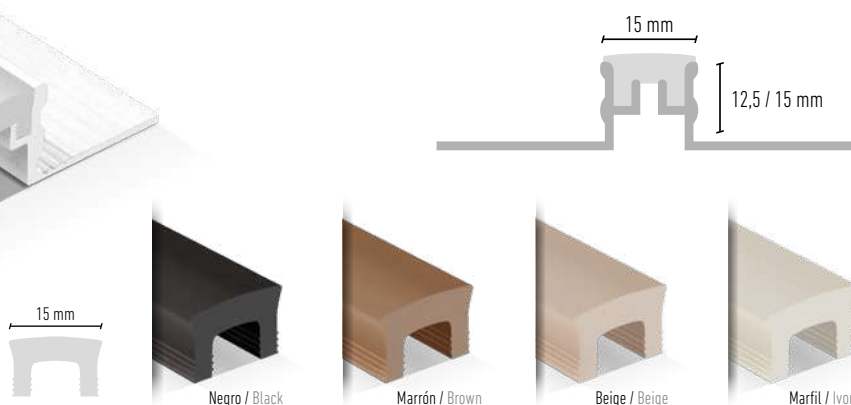

### Recambio **JD1/JD9** Junta de Goma

Rubber Replacement JD1/JD9

Medida Size	Negro Black	Marrón Brown	Beige Beige	Marfil Ivory	Longitud Length	Packing Packing
15 mm	<b>0502A180125</b>	<b>0502A090125</b>	<b>0502A080125</b>	<b>0502A060125</b>	2,50 m	25 uds./pcs.



### Junta Dilatación Aluminio **JD3**

JD3 Aluminium Expansion joint

Código Code	Medida Size	Acabado Finish	Longitud Length	Packing Packing
<b>0501A441212</b>	12 x 12 mm	Plata Mate Matt Silver	2,50 m	20 uds./pcs.
<b>0501A441215</b>	12 x 15 mm	Plata Mate Matt Silver	2,50 m	20 uds./pcs.

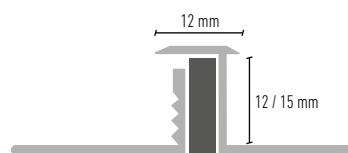



## Junta Dilatación **JD2** + Silicona

JD2 Expansion Joint + Silicone

## Junta Dilatación **JD12** Perimetral

JD12 Perimeter Expansion Joint

### Junta Dilatación Aluminio **JD2**

Aluminium Expansion Joint JD2

Código Code	Medida Size	Color Silicona Silicone Colour	Longitud Length	Packing Packing
<b>0501A021012</b>	10 x 12,5 mm	Gris Grey	2,50 m	20 uds./pcs.
<b>0501A181012</b>	10 x 12,5 mm	Negro Black	2,50 m	20 uds./pcs.
<b>0501A081012</b>	10 x 12,5 mm	Beige Beige	2,50 m	20 uds./pcs.
<b>0501A021015</b>	10 x 15 mm	Gris Grey	2,50 m	20 uds./pcs.
<b>0501A181015</b>	10 x 15 mm	Negro Black	2,50 m	20 uds./pcs.
<b>0501A081015</b>	10 x 15 mm	Beige Beige	2,50 m	20 uds./pcs.

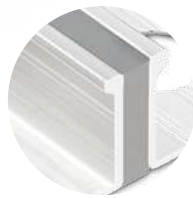
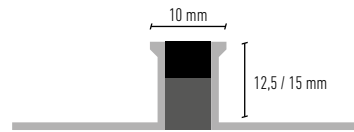

Gris / Grey



Negra / Black



Beige / Beige

### Junta Dilatación Aluminio **JD12** Perimetral + Goma

Perimeter Aluminium Expansion Joint JD12 + Rubber

Código Code	Medida Size	Acabado Finish	Longitud Length	Packing Packing
<b>0501A440012</b>	12 mm	Plata Mate Matt Silver	2,50 m	20 uds./pcs.
<b>0501A440015</b>	15 mm	Plata Mate Matt Silver	2,50 m	20 uds./pcs.

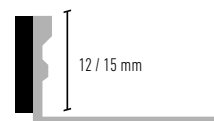



**YCR**

STAINLESS  
**STEEL**  
AISI 304

■ Junta Dilatación **JD4**

JD4 Expansion Joint

■ Junta Dilatación **JD5**

JD5 Expansion Joint



Junta Dilatación Acero Inox **JD4 + Goma**  
JD4 Inox Expansion Joint + Rubber

Código Code	Medida Size	Color Goma Rubber Colour	Longitud Length	Packing Packing
<b>05011021512</b>	15 x 12,5 mm	Gris Grey	2,50 m	20 uds./pcs.

**JUNTA MONTADA CON GOMA GRIS / GREY RUBBER INSERTED**

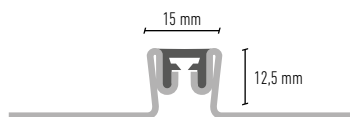

Recambio **JD4** Junta de Goma  
JD4 Rubber Replacement

Código Code	Medida Size	Acabado Finish	Longitud Length	Packing Packing
<b>05021180125</b>	15 mm	Negro Black	2,50 m	20 uds./pcs.

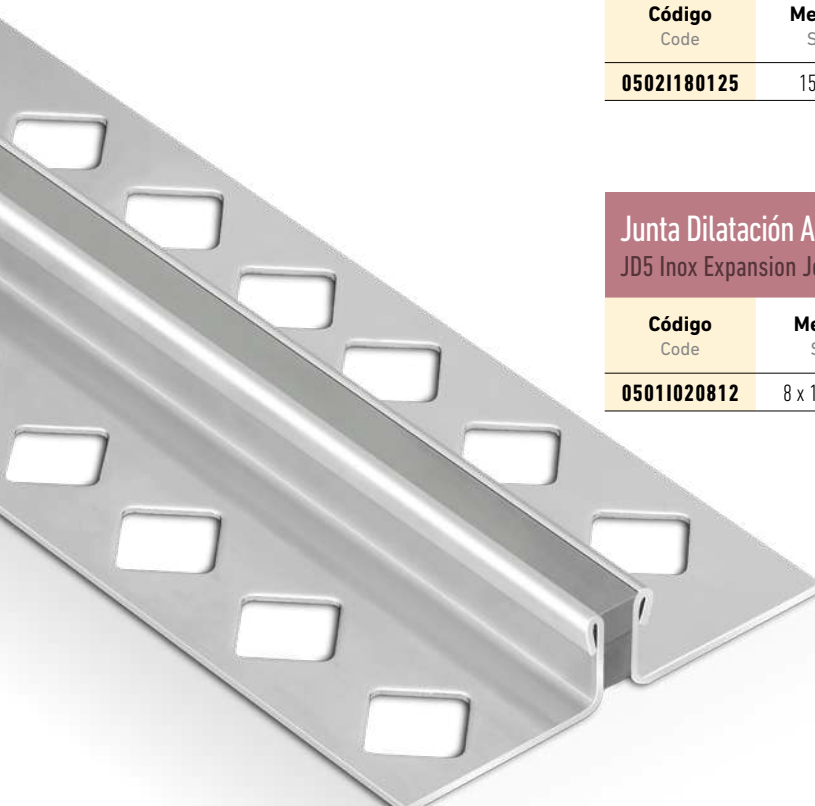

Junta Dilatación Acero Inox **JD5 + Silicona**  
JD5 Inox Expansion Joint + Silicone

Código Code	Medida Size	Color Silicona Silicone Colour	Longitud Length	Packing Packing
<b>05011020812</b>	8 x 12,5 mm	Gris Grey	2,50 m	20 uds./pcs.

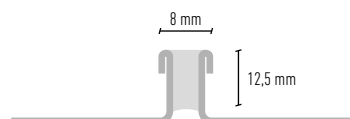



Junta Dilatación **JD6**  
JD6 Expansion Joint

Junta Dilatación **JD7**  
JD7 Expansion Joint

Junta Dilatación PVC **JD6** con ala  
JD6 PVC Expansion Joint with Wing

Código Code	Medida Size	Acabado Finish	Longitud Length	Packing Packing
0506P020812	8 x 11 mm	Gris Claro Light Grey	2,50 m	50 uds./pcs.
0506P180812	10 x 12,5 mm	Negro Black	2,50 m	20 uds./pcs.

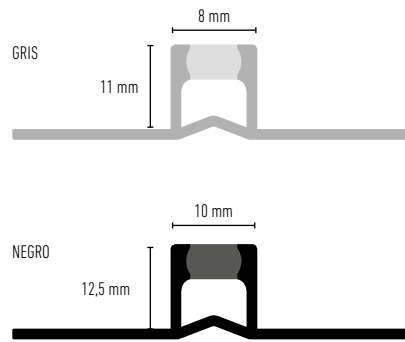

Junta Dilatación PVC **JD7** 10 / 12 / 16 mm  
JD7 PVC Expansion Joint 10 / 12 / 16 mm

Código Code	Medida Size	Acabado Finish	Longitud Length	Packing Packing
0503P020810	8 x 10 mm	Transparente Transparent	2,00 m	50 uds./pcs.
0503P020812	8 x 12 mm	Transparente Transparent	2,00 m	50 uds./pcs.
0503P020816	8 x 16 mm	Transparente Transparent	2,00 m	50 uds./pcs.

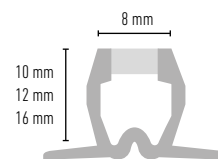

YCR



## Junta Dilatación JD8

Expansion Joint JD8

## Junta Dilatación Hormigón

Expansion Joint for Concrete



### Junta Dilatación PVC JD8 25 / 35 / 45 mm

Expansion Joint PVC JD8 25 / 35 / 45 mm

Código Code	Medida Size	Acabado Finish	Longitud Length	Packing Packing
0504P020825	8 x 25 mm	Transparente Transparent	2,50 m	40 uds./pcs.
0504P020835	8 x 35 mm	Transparente Transparent	2,50 m	40 uds./pcs.
0504P020845	8 x 45 mm	Transparente Transparent	2,50 m	40 uds./pcs.

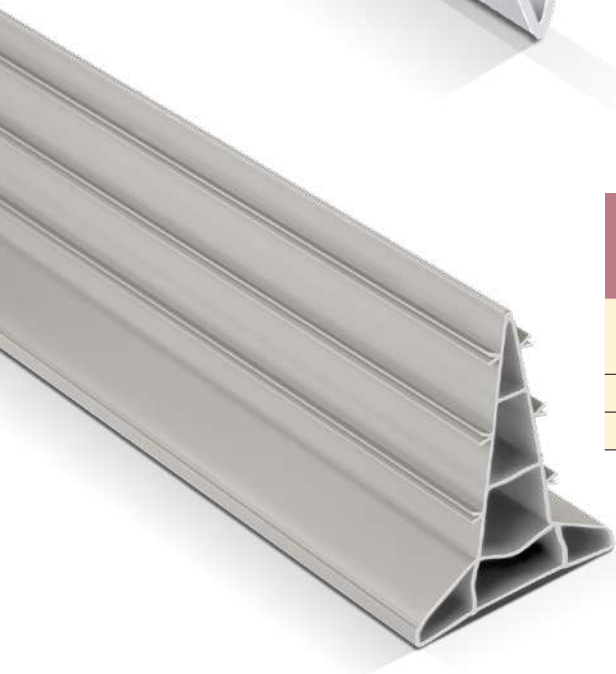
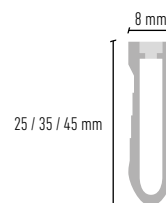

### Junta Dilatación PVC para Hormigón 40 / 80 mm

Expansion Joint PVC for Concrete 40 / 80 mm

Código Code	Medida Size	Acabado Finish	Longitud Length	Packing Packing
0505P000040	40 mm	PVC	2,50 m	34 uds./pcs.
0505P000080	80 mm	PVC	2,50 m	20 uds./pcs.

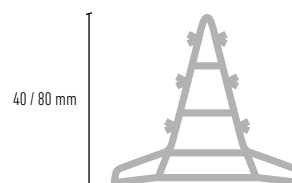

37 mm

### Soporte PVC para Junta de Hormigón

PVC Support for Concrete Expansion Joint

Código Code	Acabado Finish	Altura Soporte Support Height	Para Junta Hormigón Concrete Exp. Joint Size	Packing Packing
0505P000001	PVC	37 mm	40 mm	50 uds./pcs.
0505P000002	PVC	37 mm	80 mm	50 uds./pcs.



■ Junta Dilatación **JD11** lisa 25 mm  
JD11 Smooth Movement Joint 25 mm

■ Junta Dilatación **JD10** estriada 25 mm  
JD10 Grooved Movement Joint 25 mm

Junta de Dilatación **JD11** Estructural 25 mm / Goma LISA  
Estructural Movement Joint JD11 25 mm / Smooth Rubber

Ancho Width	Alto Height	Longitud Lenght	Gris Grey	Negra Black
25 mm	14 mm	3,00 m	<b>0508A022514</b>	<b>0508A182514</b>
25 mm	24 mm	3,00 m	<b>0508A022524</b>	<b>0508A182524</b>
25 mm	42 mm	3,00 m	<b>0508A022542</b>	<b>0508A182542</b>
25 mm	52 mm	3,00 m	<b>0508A022552</b>	<b>0508A182552</b>
25 mm	82 mm	3,00 m	<b>0508A022582</b>	<b>0508A182582</b>

Junta de Dilatación **JD10** Estructural 25 mm / Goma ESTRIADA  
Estructural Movement Joint JD10 25 mm / Grooved Rubber

Ancho Width	Alto Height	Longitud Lenght	Gris Grey	Negra Black
25 mm	14 mm	3,00 m	<b>0507A022514</b>	<b>0507A182514</b>
25 mm	24 mm	3,00 m	<b>0507A022524</b>	<b>0507A182524</b>
25 mm	42 mm	3,00 m	<b>0507A022542</b>	<b>0507A182542</b>
25 mm	52 mm	3,00 m	<b>0507A022552</b>	<b>0507A182552</b>
25 mm	82 mm	3,00 m	<b>0507A022582</b>	<b>0507A182582</b>

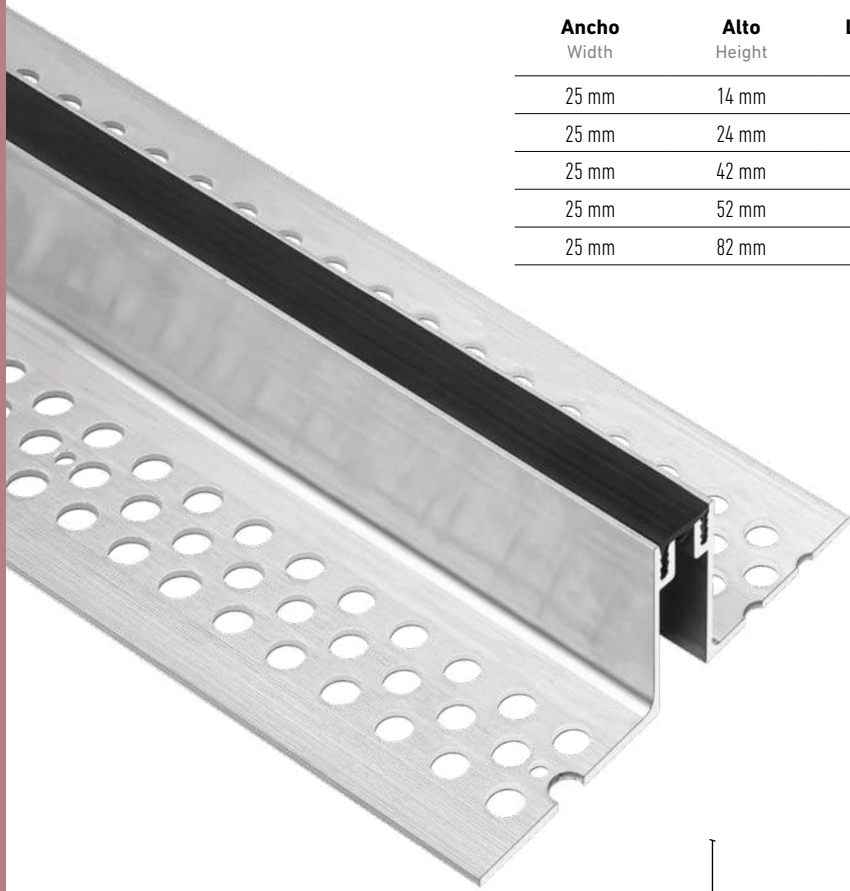

**JD11** lisa / smooth 25 mm



**JD10** estriada / grooved 25 mm

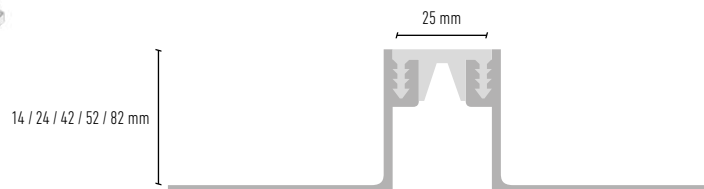



■ Junta Dilatación **JD11** lisa 35 mm

JD11 Smooth Movement Joint 35 mm

■ Junta Dilatación **JD10** estriada 35 mm

JD10 Grooved Movement Joint 35 mm

Junta de Dilatación **JD11** Estructural 35 mm / Goma LISA  
Estructural Movement Joint JD11 35 mm / Smooth Rubber

Ancho Width	Alto Height	Longitud Lenght	Gris Grey	Negra Black
35 mm	14 mm	3,00 m	<b>0508A023514</b>	<b>0508A183514</b>
35 mm	24 mm	3,00 m	<b>0508A023524</b>	<b>0508A183524</b>
35 mm	42 mm	3,00 m	<b>0508A023542</b>	<b>0508A183542</b>
35 mm	52 mm	3,00 m	<b>0508A023552</b>	<b>0508A183552</b>
35 mm	82 mm	3,00 m	<b>0508A023582</b>	<b>0508A183582</b>

Junta de Dilatación **JD10** Estructural 35 mm / Goma ESTRIADA  
Estructural Movement Joint JD10 35 mm / Grooved Rubber

Ancho Width	Alto Height	Longitud Lenght	Gris Grey	Negra Black
35 mm	14 mm	3,00 m	<b>0507A023514</b>	<b>0507A183514</b>
35 mm	24 mm	3,00 m	<b>0507A023524</b>	<b>0507A183524</b>
35 mm	42 mm	3,00 m	<b>0507A023542</b>	<b>0507A183542</b>
35 mm	52 mm	3,00 m	<b>0507A023552</b>	<b>0507A183552</b>
35 mm	82 mm	3,00 m	<b>0507A023582</b>	<b>0507A183582</b>

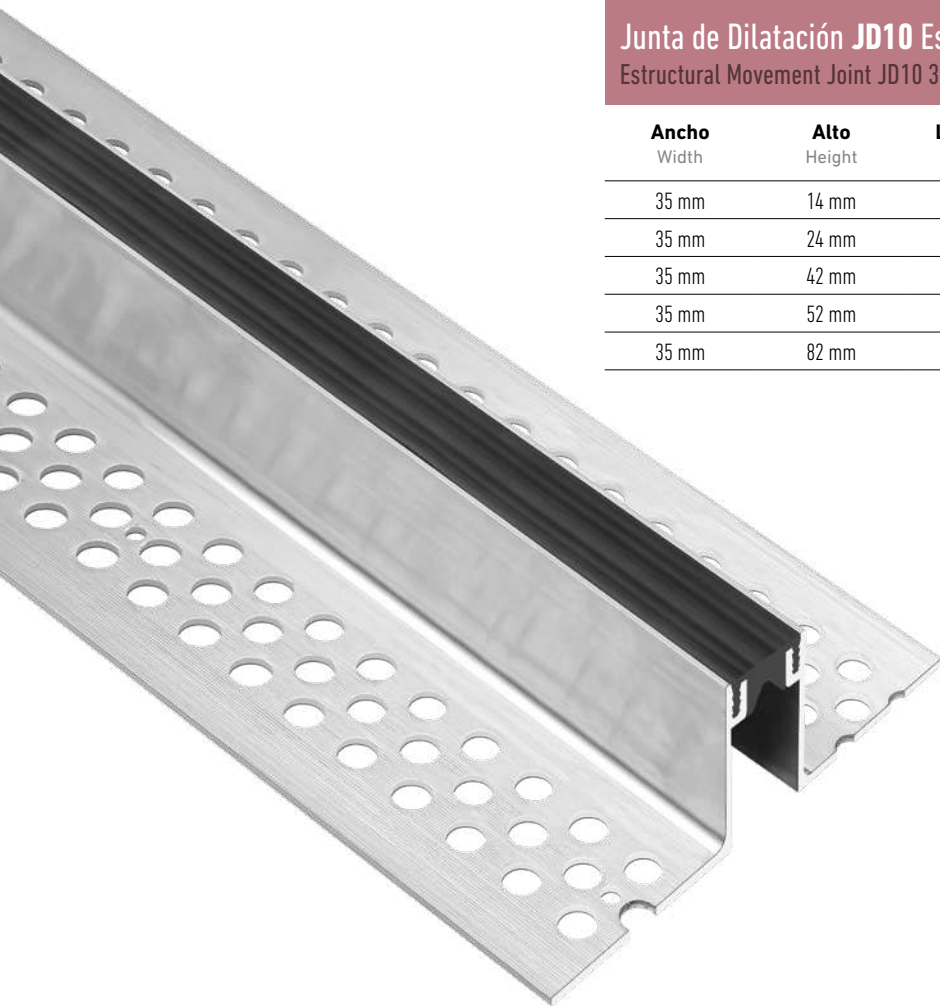

JD11 lisa / smooth 35 mm



JD10 estriada / grooved 35 mm

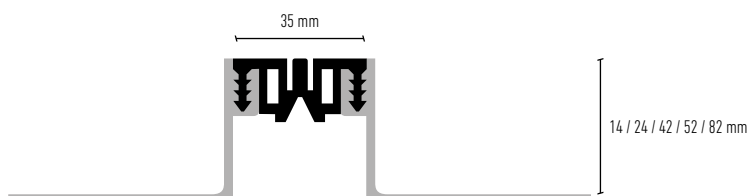



■ Junta Dilatación **JD11** lisa 45 mm  
JD11 Smooth Movement Joint 45 mm

■ Junta Dilatación **JD10** estriada 45 mm  
JD10 Grooved Movement Joint 45 mm

Junta de Dilatación **JD11** Estructural 45 mm / Goma LISA  
Estructural Movement Joint JD11 45 mm / Smooth Rubber

Ancho Width	Alto Height	Longitud Length	Gris Grey	Negra Black
45 mm	14 mm	3,00 m	0508A024514	0508A184514
45 mm	24 mm	3,00 m	0508A024524	0508A184524
45 mm	42 mm	3,00 m	0508A024542	0508A184542
45 mm	52 mm	3,00 m	0508A024552	0508A184552
45 mm	82 mm	3,00 m	0508A024582	0508A184582

Junta de Dilatación **JD10** Estructural 45 mm / Goma ESTRIADA  
Estructural Movement Joint JD10 45 mm / Grooved Rubber

Ancho Width	Alto Height	Longitud Length	Gris Grey	Negra Black
45 mm	14 mm	3,00 m	0507A024514	0507A184514
45 mm	24 mm	3,00 m	0507A024524	0507A184524
45 mm	42 mm	3,00 m	0507A024542	0507A184542
45 mm	52 mm	3,00 m	0507A024552	0507A184552
45 mm	82 mm	3,00 m	0507A024582	0507A184582

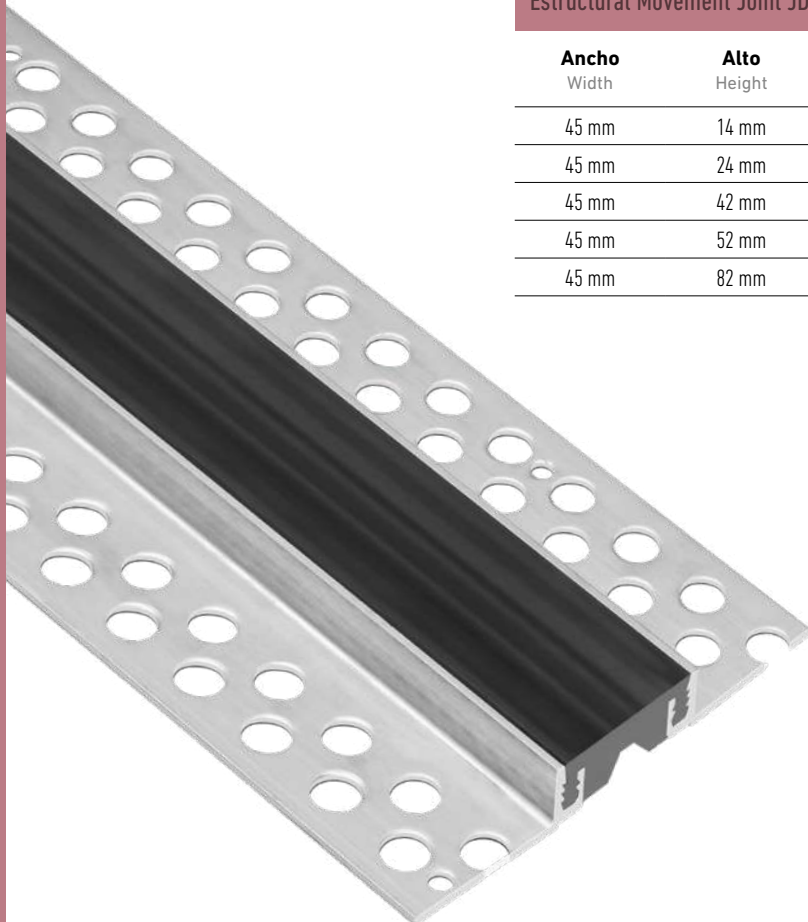

JD11 lisa / smooth 45 mm



JD10 estriada / grooved 45 mm

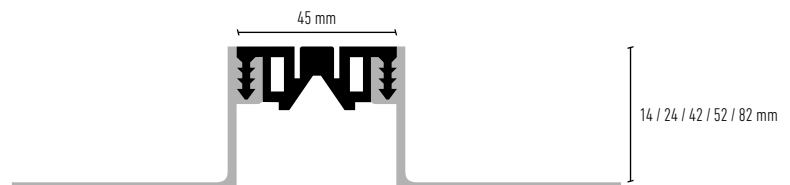

# ZÓCALOS y ESCOCIAS

SKIRTING BOARD & INTERNAL ANGLES





**Zócalo Z1 LED**  
Skirting Board Z1 Led

**Zócalo Z1**  
Skirting Board Z1



**Zócalo Z1 LED Aluminio**  
Aluminium Skirting Board Z1 Led

Código Code	Altura Height	Acabado Finish	Longitud Length	Packing Packing
<b>0310A440000</b>	80 mm	Plata Mate Matt Silver	2,50 m	10 uds./pcs.
<b>0310A010000</b>	80 mm	Blanco White	2,50 m	10 uds./pcs.

**NO INCLUYE TIRA LED / LED STRING NOT INCLUDED**

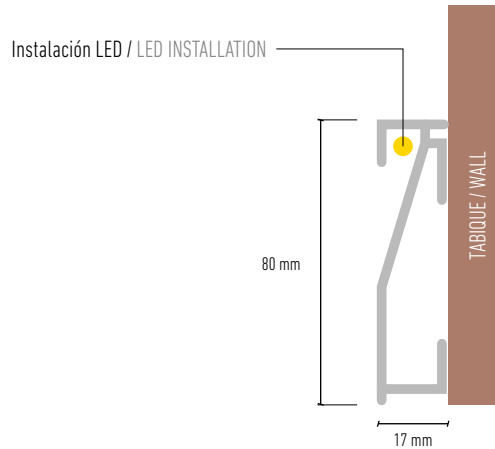

**Zócalo Z1 Aluminio**  
Aluminium Skirting Board Z1

Código Code	Altura Height	Acabado Finish	Longitud Length	Packing Packing
<b>0306A442508</b>	80 mm	Plata Mate Matt Silver	2,50 m	12 uds./pcs.
<b>0306A012508</b>	80 mm	Blanco White	2,50 m	12 uds./pcs.

**2 COLOCACIONES**  
2 INSTALLATIONS TYPES:

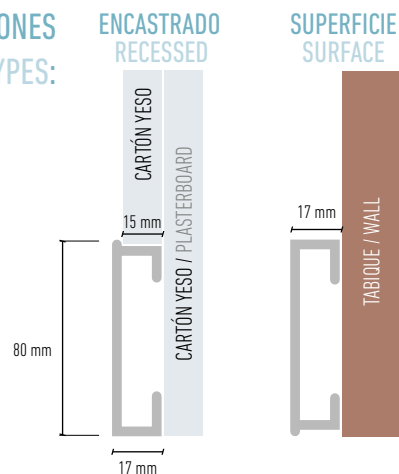





# Esquina Z1 Universal 4 en 1

4 in 1 Universal Corner Z1

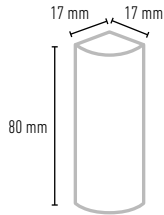

## Esquina Z1 Universal Aluminio

Aluminum Universal Corner Z1

Código Code	Altura Height	Acabado Finish	Packing Packing
<b>0306A440000</b>	80 mm	Plata Mate Matt Silver	1 uds./pcs.
<b>0306A010000</b>	80 mm	Blanco White	1 uds./pcs.



Esquina Interior / Internal Corner



Esquina Exterior / External Corner



Terminal Izquierda / Left Terminal

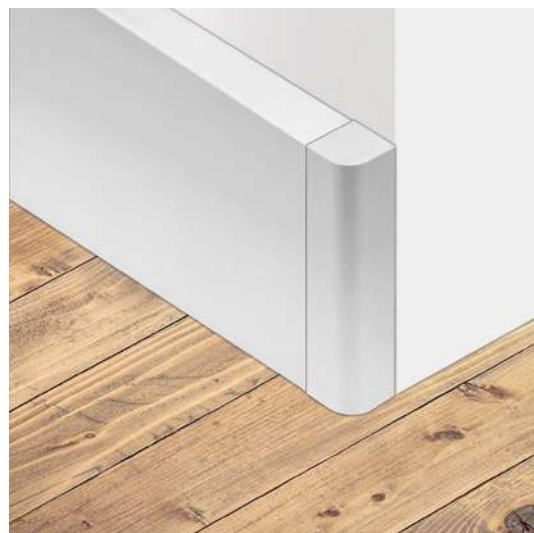

Terminal Derecha / Right Terminal



**Zócalo Z6**  
Skirting Board Z6

**Zócalo Z6 Poliestireno Extruido**  
Extruded Polystyrene Skirting Board Z6

Código Code	Altura Height	Espesor Thickness	Acabado Finish	Longitud Length	Packing Packing
0311P017010	70 mm	10 mm	Blanco White	2,25 m	20 uds./pcs.
0311P017015	70 mm	15 mm	Blanco White	2,44 m	14 uds./pcs.
0311P019010	90 mm	10 mm	Blanco White	2,25 m	20 uds./pcs.
0311P019015	90 mm	15 mm	Blanco White	2,44 m	12 uds./pcs.

CAJAS INDIVISIBLES / INDIVISIBLE PACKING

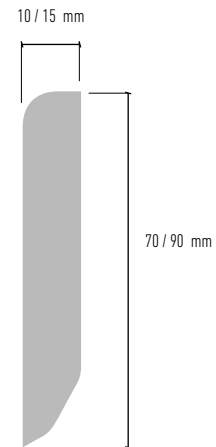
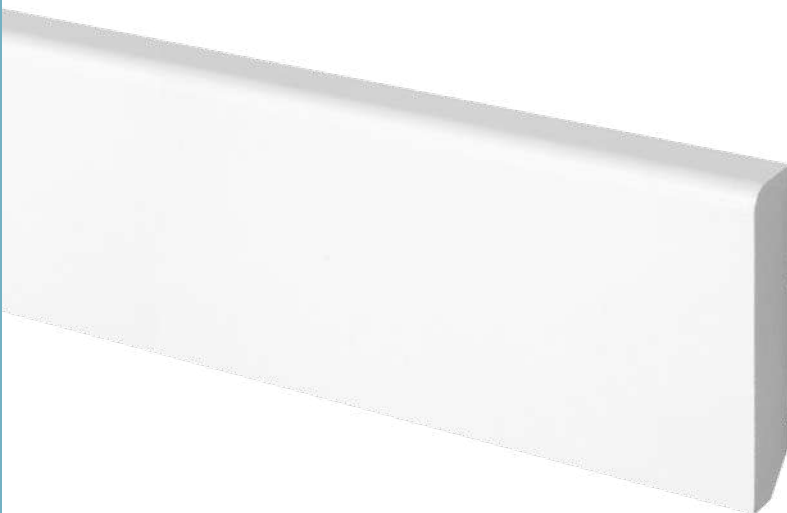

**fácil manipulación**  
easy handling



**pintable**  
paintable



**anti humedad**  
anti humidity



# Zócalo Z2

## Skirting Board Z2

### Zócalo Z2 Aluminio

#### Aluminium Skirting Board

Altura Height	Blanco White	Plata Mate Matt Silver	Longitud Length	Packing Packing
60 mm	<b>0307A016250</b>	<b>0307A446250</b>	2,50 m	10 uds./pcs.
80 mm	<b>0307A018250</b>	<b>0307A448250</b>	2,50 m	10 uds./pcs.
100 mm	<b>0307A011250</b>	<b>0307A441250</b>	2,50 m	10 uds./pcs.



### Esquina Exterior Z2 Aluminio

#### Aluminium External Corner Z2



Altura Height	Blanco White	Plata Mate Matt Silver
60 mm	<b>0305A010001</b>	<b>0305A440001</b>
80 mm	<b>0307A010001</b>	<b>0307A440001</b>
100 mm	<b>0310A010001</b>	<b>0310A440001</b>

### Esquina Interior Z2 Aluminio

#### Aluminium Internal Corner Z2



Altura Height	Blanco White	Plata Mate Matt Silver
60 mm	<b>0305A010002</b>	<b>0305A440002</b>
80 mm	<b>0307A010002</b>	<b>0307A440002</b>
100 mm	<b>0310A010002</b>	<b>0310A440002</b>

### Conector Z2 Aluminio

#### Aluminium Z2 Connector



Altura Height	Blanco White	Plata Mate Matt Silver
60 mm	<b>0305A010003</b>	<b>0305A440003</b>
80 mm	<b>0307A010003</b>	<b>0307A440003</b>
100 mm	<b>0310A010003</b>	<b>0310A440003</b>

### Terminal Derecha Z2 Aluminio

#### Aluminium Right Terminal Z2



Altura Height	Blanco White	Plata Mate Matt Silver
60 mm	<b>0305A010004</b>	<b>0305A440004</b>
80 mm	<b>0307A010004</b>	<b>0307A440004</b>
100 mm	<b>0310A010004</b>	<b>0310A440004</b>

### Terminal Izquierda Z2 Aluminio

#### Aluminium Left Terminal Z2



Altura Height	Blanco White	Plata Mate Matt Silver
60 mm	<b>0305A010005</b>	<b>0305A440005</b>
80 mm	<b>0307A010005</b>	<b>0307A440005</b>
100 mm	<b>0310A010005</b>	<b>0310A440005</b>





**YCR**

**Zócalo Z4**  
Skirting Board Z4

**Zócalo Z5**  
Skirting Board Z5

**Zócalo Z4 Aluminio**  
Aluminium Skirting Board Z4

Altura x Prof. Height x Depth	Blanco White	Plata Mate Matt Silver	Longitud Length	Packing Packing
70 x 13 mm	<b>0308A011370</b>	<b>0308A441370</b>	2,50 m	20 uds./pcs.
70 x 15 mm	<b>0308A011570</b>	<b>0308A441570</b>	2,50 m	20 uds./pcs.

**NO INCLUYE TIRA LED / DOES NOT INCLUDE LED STRIP**

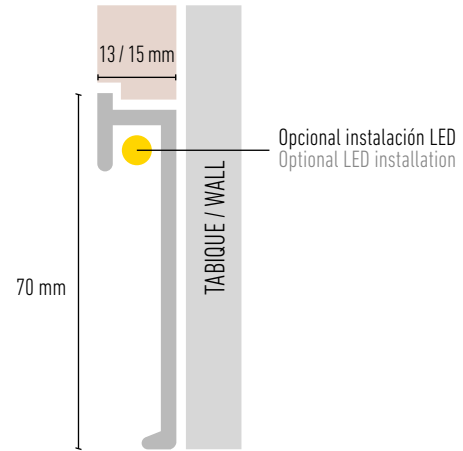

**Zócalo Z5 Aluminio**  
Aluminium Skirting Board Z5

Altura x Prof. Height x Depth	Blanco White	Plata Mate Matt Silver	Longitud Length	Packing Packing
80 x 14 mm	<b>0309A011480</b>	<b>0309A441480</b>	2,50 m	20 uds./pcs.
120 x 22 mm	<b>0309A012412</b>	<b>0309A442412</b>	2,50 m	20 uds./pcs.

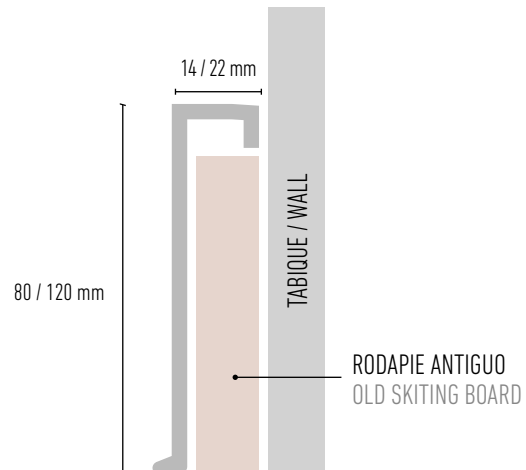



# Zócalo Z3

Skirting Board Z3



## Zócalo Z3 PVC

PVC Skirting Board Z3

Código Code	Altura Height	Acabado Finish	Longitud Length	Packing Packing
0305P016250	60 mm	Blanco White	2,50 m	20 uds./pcs.
0305P186250	60 mm	Negro Black	2,50 m	20 uds./pcs.
0305P446250	60 mm	Plata Mate Matt Silver	2,50 m	20 uds./pcs.

## Esquina Exterior Z3 PVC h.6

PVC External Corner Z3

Código Code	Acabado Finish	Packing Packing
0305P010001	Blanco White	1 ud.
0305P180001	Negro Black	1 ud.
0305P440001	Plata Mate Matt Silver	1 ud.

## Esquina interior Z3 PVC h.6

PVC Internal Corner Z3

Código Code	Acabado Finish	Packing Packing
0305P010002	Blanco White	1 ud.
0305P180002	Negro Black	1 ud.
0305P440002	Plata Mate Matt Silver	1 ud.

## Conector Z3 PVC h.6

PVC Connector Z3

Código Code	Acabado Finish	Packing Packing
0305P010003	Blanco White	1 ud.
0305P180003	Negro Black	1 ud.
0305P440003	Plata Mate Matt Silver	1 ud.

## Terminal Derecha Z3 PVC h.6

PVC Right Terminal Z3

Código Code	Acabado Finish	Packing Packing
0305P010004	Blanco White	1 ud.
0305P180004	Negro Black	1 ud.
0305P440004	Plata Mate Matt Silver	1 ud.

## Terminal Izquierda Z3 PVC h.6

PVC Left Terminal Z3

Código Code	Acabado Finish	Packing Packing
0305P010005	Blanco White	1 ud.
0305P180005	Negro Black	1 ud.
0305P440005	Plata Mate Matt Silver	1 ud.

### COLORES / COLOURS

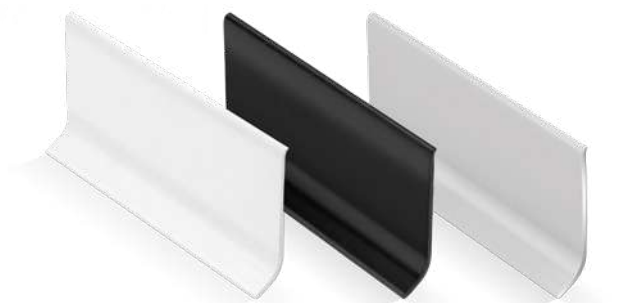

Blanco / White    Negro / Black    Plata Mate / Matt Silver





# Escocia E1

## E1 Internal Angle Trim

### Escocia E1 Aluminio 20 x 20 x 30 mm

#### Aluminium Internal Angle Trim 20 x 20 x 30 mm

Código Code	Medida Size	Acabado Finish	Longitud Length	Packing Packing
0301A442020	20 x 20 x 30 mm	Mate Matt	2,50 m	25 uds./pcs.
0301A012020	20 x 20 x 30 mm	Blanco White	2,50 m	25 uds./pcs.
0301A432020	20 x 20 x 30 mm	Brillo Polished	2,50 m	25 uds./pcs.

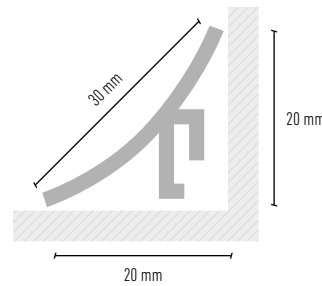

### Esquina EXTERIOR Escocia E1

#### External Corner E1

Plata Mate Matt Silver	Plata Brillo Polished Silver	Blanco White	Packing Packing
0301A440001	0301A430001	0301A010001	5 uds./pcs.

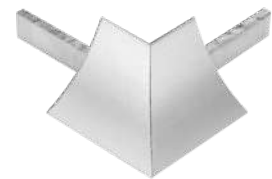

Esquina Exterior  
External Corner

### Esquina INTERIOR Escocia E1

#### Internal Corner E1

Plata Mate Matt Silver	Plata Brillo Polished Silver	Blanco White	Packing Packing
0301A440002	0301A430002	0301A010002	5 uds./pcs.



Esquina Interior  
Internal Corner

### TAPA FINAL Escocia E1

#### End Cap E1

Plata Mate Matt Silver	Plata Brillo Polished Silver	Blanco White	Packing Packing
0301A440003	0301A430003	0301A010003	5 uds./pcs.



Tapa final  
End Cap

STAINLESS  
**STEEL**  
AISI 304

## Escocia E2

E2 Internal Angle Trim



**Escocia E2 Acero Inox 20 x 20 x 30 mm**  
Inox Internal Angle Trim E2 20 x 20 x 30 mm

Código Code	Medida Size	Acabado Finish	Longitud Length	Packing Packing
<b>03021432020</b>	20 x 20 x 30 mm	Brillo Polished	2,50 m	10 uds./pcs.

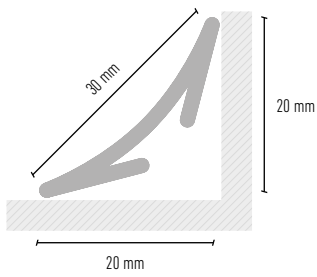

### Esquina EXTERIOR Escocia E2

External Corner E2

Código Code	Descripción Description	Acabado Finish	Packing Packing
<b>03021430001</b>	Esquina Ext. Ext. Corner	Brillo Polished	5 uds./pcs.



Esquina Exterior  
External Corner

### Esquina INTERIOR 3 VÍAS Escocia E2

Internal Corner 3 Ways E2

Código Code	Descripción Description	Acabado Finish	Packing Packing
<b>03021430004</b>	Esquina Int. 3 Vías Internal Corner 3 Ways	Brillo Polished	5 uds./pcs.



Esquina Int. 3 vías  
Internal Corner 3 ways

### Esquina INTERIOR 2 VÍAS Escocia E2

Internal Corner 2 Ways E2

Código Code	Descripción Description	Acabado Finish	Packing Packing
<b>03021430002</b>	Esquina Int. 2 Vías Internal Corner 2 Ways	Brillo Polished	5 uds./pcs.



Esquina Int. 2 vías  
Internal Corner 2 ways

### TAPA FINAL Escocia E2

End Cap E2

Código Code	Descripción Description	Acabado Finish	Packing Packing
<b>03021430003</b>	Tapa Final End Cap	Brillo Polished	5 uds./pcs.



Tapa Final  
End Cap



**Escocia E3**  
E3 Internal Angle Trim

**Escocia E4**  
E4 Internal Angle Trim



**Escocia E3 Aluminio 13 x 20 mm**  
Aluminium Internal Angle E3 13 x 20 mm

Código Code	Medida Size	Acabado Finish	Longitud Length	Packing Packing
<b>0303A431320</b>	13x20 mm	Brillo Polished	2,60 m	25 uds./pcs.
<b>0303A441320</b>	13x20 mm	Mate Matt	2,60 m	25 uds./pcs.

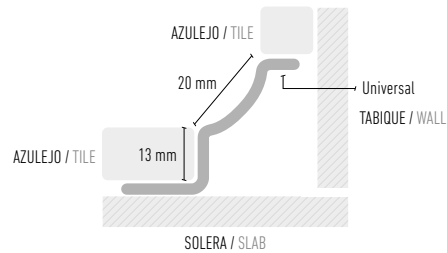

**Escocia E4 PVC 20 x 20 x 30 mm**  
PVC Internal Angle E4 20 x 20 x 30 mm

Código Code	Medida Size	Acabado Finish	Longitud Length	Packing Packing
<b>0304P012020</b>	20x20x30 mm	Blanco White	2,50 m	40 uds./pcs.
<b>0304P010001</b>	Esquina Ext. External Corner	Blanco White	-	5 uds./pcs.
<b>0304P010002</b>	Esquina Int. Internal Corner	Blanco White	-	5 uds./pcs.
<b>0304P010003</b>	Tapa Final End Cap	Blanco White	-	5 uds./pcs.



Tapa Final  
End Cap

Esquina Exterior 2 vias  
External Corner 2 ways

Esquina Interna 2 vias  
Internal Corner 2 ways

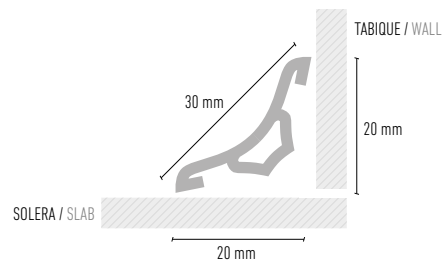



The image shows a close-up of a wall made of glass blocks. A central vertical strip of a different material, possibly a metal or plastic frame, runs down the middle. The glass blocks are arranged in a grid pattern, with some showing a grid pattern on their surface. The text is overlaid on the right side of the image.

# ACCESORIOS PARA PAVÉS

## GLASS BLOCKS ACCESSORIES

GLASS BLOCKS ACCESSORIES / ACCESORIOS PAVÉS

YCR

## ■ Separador Pavés

Glass Block Spacer

## ■ Varilla Galvanizada

Galvanized Rod

## ■ Varilla F.V.

Fiberglass Rod

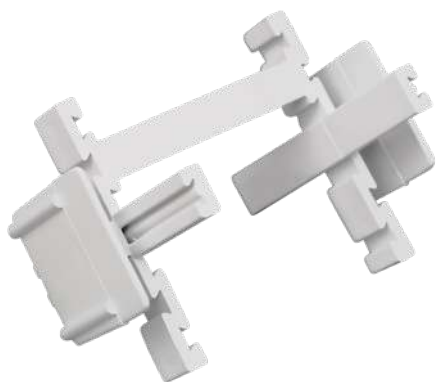

### Separador Pavés

Glass Block Spacer

Código Code	Medida Size	Acabado Finish	Packing Packing
4904P000010	10 mm	Polipropileno Polypropylene	300 uds./pcs.
CAJAS INDIVISIBLES / INDIVISIBLE PACKING			



### Varillas Pavés GALVANIZADA

Galvanized Rod

Código Code	Medida Size	Material Material	Longitud Length	Packing Packing
4905P003006	Ø 6 mm	Galvanizada Galvanized	3,00 m	50 uds./pcs.
OTRAS MEDIDAS Y ESPESORES CONSULTAR / DIFFERENTS MEASURES AND THICKNESSES AVAILABLES				
CAJAS INDIVISIBLES / INDIVISIBLE PACKING				



### Varillas Pavés FV

Fiberglass Rod

Código Code	Medida Size	Material Material	Longitud Length	Packing Packing
4905V003006	Ø 6 mm	Fibra Vidrio Fiberglass	3,00 m	50 uds./pcs.
OTRAS MEDIDAS Y ESPESORES CONSULTAR / DIFFERENTS MEASURES AND THICKNESSES AVAILABLES				



■ Perfil Terminal **Curvo** para Pavés  
Terminal Curve Profile

■ Perfil Terminal **Recto** para Pavés  
Terminal Straight Profile

**Perfil Terminal CURVO**  
Curve Profiles for Glass Blocks

Código Code	Color Colour	Longitud Length	Packing Packing
<b>4910A010200</b>	Blanco White	2,00 m	6 uds./pcs.
<b>4910A010300</b>	Blanco White	3,00 m	6 uds./pcs.
<b>4910A430200</b>	Plata Brillo Polished Silver	2,00 m	6 uds./pcs.
<b>4910A430300</b>	Plata Brillo Polished Silver	3,00 m	6 uds./pcs.
<b>4910A440200</b>	Plata Mate Matt Silver	2,00 m	6 uds./pcs.
<b>4910A440300</b>	Plata Mate Matt Silver	3,00 m	6 uds./pcs.

Se suministra con un extremo cortado en inglete  
Supplied with a mitered end

**Perfil Terminal RECTO**  
Straight Profiles for Glass Blocks

Código Code	Color Colour	Longitud Length	Packing Packing
<b>4908A010200</b>	Blanco White	2,00 m	6 uds./pcs.
<b>4908A010300</b>	Blanco White	3,00 m	6 uds./pcs.
<b>4908A430200</b>	Plata Brillo Polished Silver	2,00 m	6 uds./pcs.
<b>4908A430300</b>	Plata Brillo Polished Silver	3,00 m	6 uds./pcs.
<b>4908A440200</b>	Plata Mate Matt Silver	2,00 m	6 uds./pcs.
<b>4908A440300</b>	Plata Mate Matt Silver	3,00 m	6 uds./pcs.

Se suministra con un extremo cortado en inglete  
Supplied with a mitered end

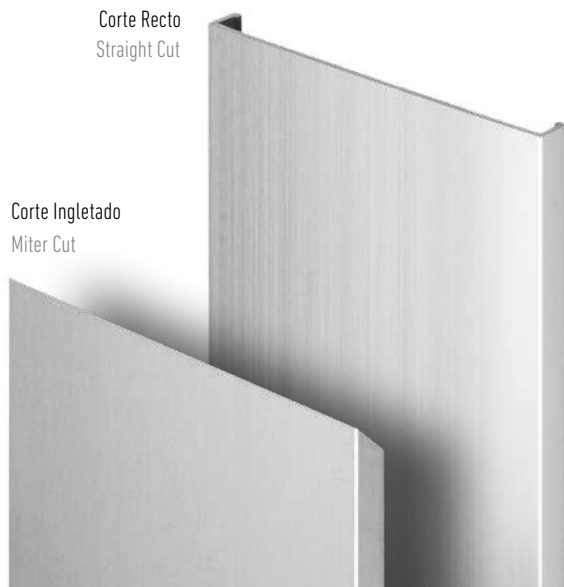
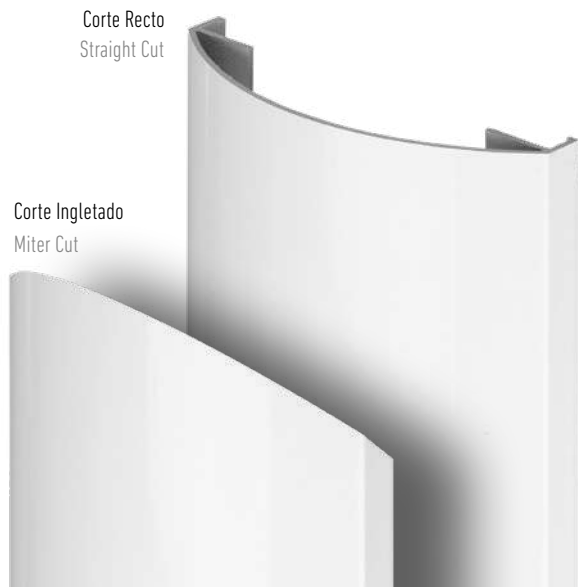
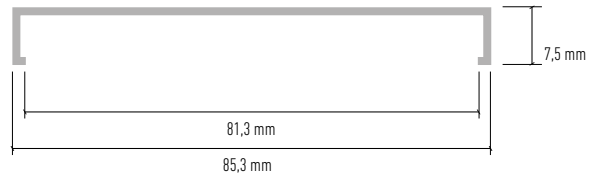
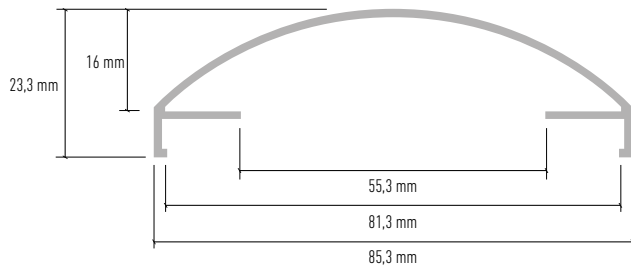



# GUARDAVIVOS

CORNER PROFILES

## Perfiles Enlucido **Yeso** Corner Profiles For Plaster

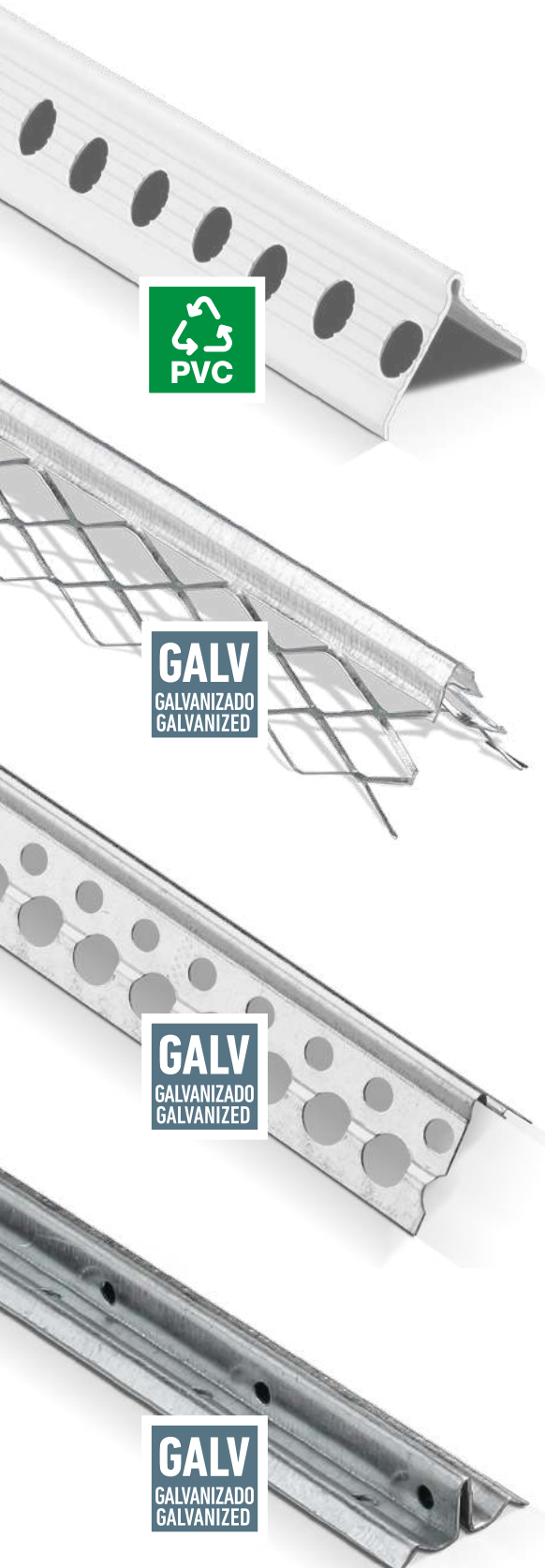

### Guardavivo Yeso PVC PVC Corner Bead

Código Code	Medida Size	Material Material	Longitud Length	Packing Packing
5001P010250	-	PVC PVC	2,50 m	100 uds./pcs.
5001P010260	-	PVC PVC	2,60 m	100 uds./pcs.
5001P010300	-	PVC PVC	3,00 m	100 uds./pcs.

CAJAS INDIVISIBLES / INDIVISIBLE PACKING

OTRAS LONGITUDES CONSULTAR / ASK OTHER LENGTHS



### Guardavivo Deploye Galvanizado Galvanized Corner Bead Mesh

Código Code	Medida Size	Material Material	Longitud Length	Packing Packing
50026000250	-	Galvanizado Galvanized	2,50 m	100 uds./pcs.

CAJAS INDIVISIBLES / INDIVISIBLE PACKING

OTRAS LONGITUDES CONSULTAR / ASK OTHER LENGTHS



### Guardavivo Galvanizado Chapa Perforada Perforated Galvanized Corner Bead

Código Code	Medida Size	Material Material	Longitud Length	Packing Packing
50036000250	25 x 25 mm	Galvanizado Galvanized	2,50 m	60 uds./pcs.

CAJAS INDIVISIBLES / INDIVISIBLE PACKING



### Guia Maestra Galvanizada Galvanized Master Guide

Código Code	Medida Size	Material Material	Longitud Length	Packing Packing
50046002506	6 mm	Galvanizado Galvanized	2,50 m	50/100 uds./pcs.
50046002510	10 mm	Galvanizado Galvanized	2,50 m	50/100 uds./pcs.

CAJAS INDIVISIBLES / INDIVISIBLE PACKING





Perfiles PVC Enlucido con Malla  
PVC Plaster Profiles with Mesh

Goterón PVC + Malla FV  
PVC Balcony Profile with Mesh

Código Code	Medida Size	Material Material	Longitud Length	Packing Packing
5015P011010	100 x 100 mm	PVC + Fibra de Vidrio PVC + Fiberglass	2,50 m	25 uds./pcs.

CAJAS INDIVISIBLES / INDIVISIBLE PACKING

CINTA DE PROTECCIÓN ADHESIVA  
ADHESIVE PROTECTION TAPE

Guardavivo PVC + Malla FV  
PVC Corner Profile with Fiberglass Mesh

Código Code	Medida Size	Material Material	Longitud Length	Packing Packing
5013P018012	80 x 120 mm	PVC + FV PVC + FG	2,50 m	50 uds./pcs.

CAJAS INDIVISIBLES / INDIVISIBLE PACKING

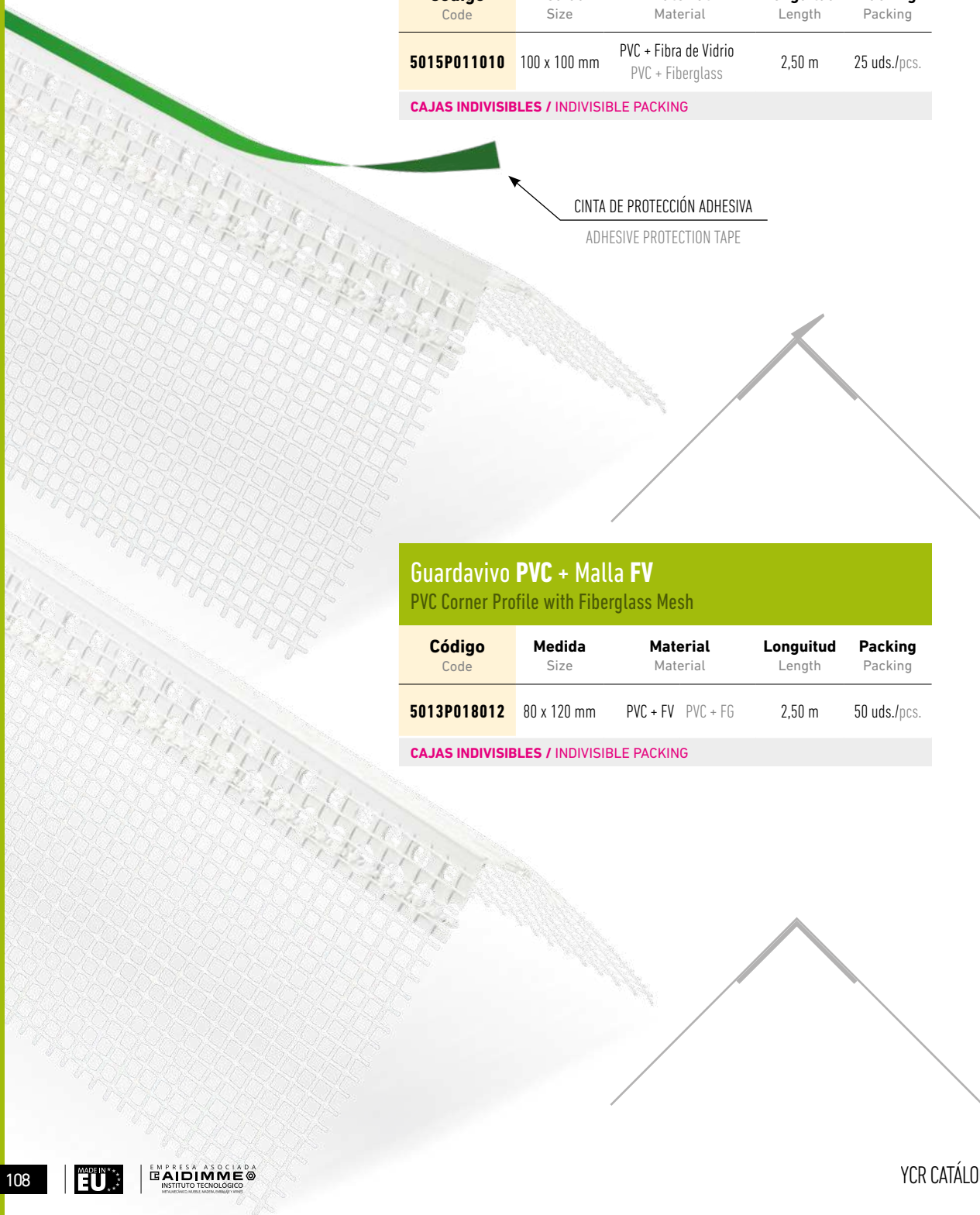



# Perfiles Enlucido Invisibles

Invisible PVC Plaster Profiles



## Guardavivo Monocapa Invisible PVC

PVC Invisible Profile

Código Code	Medida Size	Material Material	Longitud Length	Packing Packing
5005P012506	Pequeño Small	PVC PVC	2,50 m	60 uds./pcs.
5005P012510	Standard Standard	PVC PVC	2,50 m	50 uds./pcs.
5005P012512	Grande Big	PVC PVC	2,50 m	50 uds./pcs.

CAJAS INDIVISIBLES / INDIVISIBLE PACKING

OTRAS LONGITUDES CONSULTAR / ASK OTHER LENGTHS

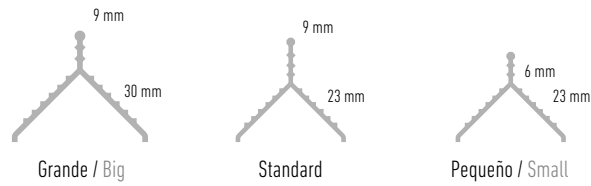

## Guardavivo Invisible PVC + Malla FV

PVC Invisible Profile + Fiberglass Mesh

Código Code	Altura Height	Material Material	Medida Size	Longitud Length	Packing Packing
5014P012503	3 mm	PVC + FV PVC + FG	10 x 15 cm	2,50 m	50 uds./pcs.
5014P012506	6 mm	PVC + FV PVC + FG	8 x 12 cm	2,50 m	50 uds./pcs.

CAJAS INDIVISIBLES / INDIVISIBLE PACKING

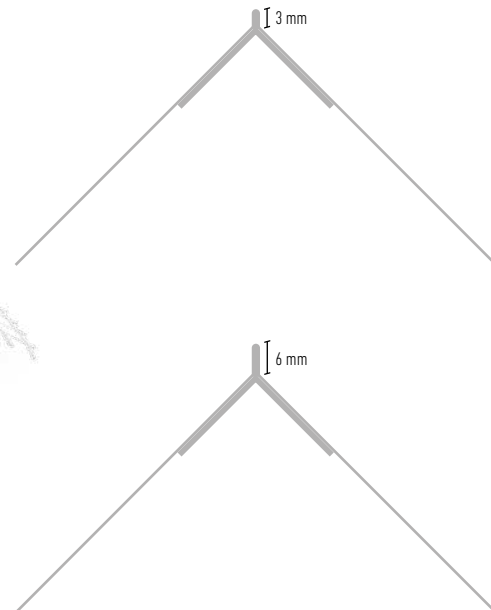

## Perfiles Enlucido Monocapa

### Monolayer Plaster Profiles

#### Guardavivo Monocapa Galvanizado con PVC Blanco

##### PVC and Galvanized Monolayer Profile

Código Code	Medida Size	Material Material	Longitud Length	Packing Packing
50066000250	-	Galvanizado + PVC Galvanized + PVC	2,50 m	20 uds./pcs.
CAJAS INDIVISIBLES / INDIVISIBLE PACKING				
OTRAS LONGITUDES CONSULTAR / ASK OTHER LENGTHS				

GALV  
GALVANIZADO  
GALVANIZED



#### Guardavivo Monocapa Exterior PVC

##### PVC External Monolayer Profile

Código Code	Medida Size	Material Material	Longitud Length	Packing Packing
5007P010250	-	PVC PVC	2,50 m	50 uds./pcs.
CAJAS INDIVISIBLES / INDIVISIBLE PACKING				
OTROS COLORES CONSULTAR / ASK OTHER COLOURS				

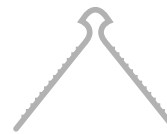

#### Junquillo Monocapa PVC

##### PVC Outdoor Rendering

Código Code	Medida Size	Material Material	Longitud Length	Packing Packing
5008P000200	2 cm	PVC PVC	2,00 m	130 uds./pcs.
5008P000400	4 cm	PVC PVC	2,00 m	70 uds./pcs.
CAJAS INDIVISIBLES / INDIVISIBLE PACKING				





# Guardavivos Enlucido **Flexibles**

## Flexible Plaster Profiles



### Guardavivo Yeso Flexible **Galvanizado**

#### Flexible Galvanized Profile

Código Code	Medida Size	Material Material	Longitud Length	Packing Packing
<b>50166000300</b>	30 x 20 mm	Galvanizado Galvanized	3,00 m	25 uds./pcs.

Se utiliza para la protección de las esquinas en enlucidos curvos.  
It is used for the protection of the corners in curved plasters.

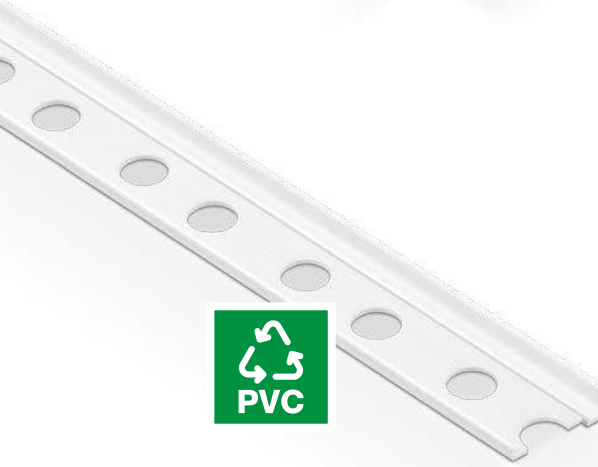
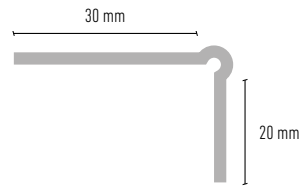

### Guardavivo Yeso Flexible **PVC**

#### Flexible PVC Profile

Código Code	Medida Size	Material Material	Longitud Length	Packing Packing
<b>5013P000300</b>	-	PVC PVC	3,00 m	100 uds./pcs.

Se utiliza para la protección de las esquinas en enlucidos curvos.  
It is used for the protection of corners in curved plasters.

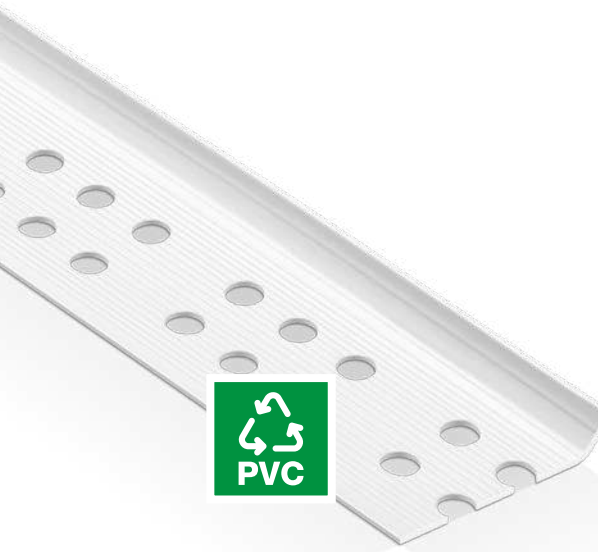

### Guardavivo Monocapa Flexible **PVC**

#### Flexible PVC Monolayer Profile

Código Code	Medida Size	Material Material	Longitud Length	Packing Packing
<b>5012P000250</b>	-	PVC PVC	2,50 m	100 uds./pcs.

Se utiliza para la protección de las esquinas en enlucidos curvos.  
It is used for the protection of corners in curved plasters.





**YCR**

**Guard. Cartón Yeso PVC ROLL** Auto-adhesivo  
 PVC Roll Self-Adhesive Plasterboard Profile

**Guardavivo ROLL** Auto-adhesivo Cartón Yeso PVC  
 PVC Roll Self-adhesive Plasterboard Profile

Código Code	Longitud Length	Ancho Width	Material Material	Packing Packing
<b>5010P015025</b>	25 m	50 mm	PVC PVC	10 uds./pcs.

**CAJAS INDIVISIBLES / INDIVISIBLE PACKING**

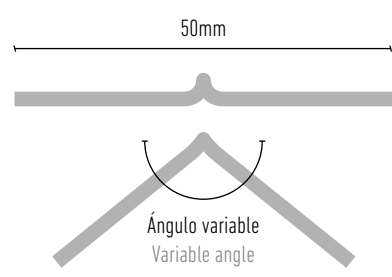

**You Tube**  
**PVC ROLL**  
 VIDEO TUTORIAL  
 •GUARD. CARTÓN YESO  
 •PLASTERBOARD PROFILE



# YCR

## Guardavivo Cartón Yeso PVC

Plasterboard PVC Profile

## Medio Guardavivo Cartón Yeso PVC

Half Edge Plasterboard PVC Profile

## Guardavivo Cartón Yeso PVC J

Edge Plasterboard PVC J Profile

### Guardavivo Cartón Yeso PVC

Plasterboard PVC Profile

Código Code	Medida Size	Material Material	Longitud Length	Packing Packing
5010P010260	25 x 25 mm	PVC PVC	2,60 m	100 uds./pcs.
5010P010300	25 x 25 mm	PVC PVC	3,00 m	100 uds./pcs.

CAJAS INDIVISIBLES / INDIVISIBLE PACKING

### Medio Guardavivo Cartón Yeso PVC

Half Edge Plasterboard PVC Protector

Código Code	Medida Size	Material Material	Longitud Length	Packing Packing
5009P000260	23 x 14 mm	PVC PVC	2,60 m	100 uds./pcs.
5009P000300	23 x 14 mm	PVC PVC	3,00 m	100 uds./pcs.

CAJAS INDIVISIBLES / INDIVISIBLE PACKING

### Perfil Cartón Yeso PVC J Blanco

White Edge Plasterboard PVC J

Código Code	Medida Size	Material Material	Longitud Length	Packing Packing
5016P010305	12,5 mm	PVC PVC	3,05 m	50 uds./pcs.

CAJAS INDIVISIBLES / INDIVISIBLE PACKING

**NEW**

## Guard. Cartón Yeso **Metálicos**

### Metallic Plasterboard Profiles

#### Guardavivo Cartón Yeso **Galvanizado**

##### Galvanized Plasterboard Profiles

Código Code	Medida Size	Material Material	Longitud Length	Packing Packing
5011G000250	25 x 25 mm	Galvanizado Galvanized	2,50 m	100 uds./pcs.
5011G000300	25 x 25 mm	Galvanizado Galvanized	3,00 m	100 uds./pcs.

CAJAS INDIVISIBLES / INDIVISIBLE PACKING

**GALV**  
GALVANIZADO  
GALVANIZED



#### Guardavivo Cartón Yeso **Aluminio**

##### Aluminium Plasterboard Profile

Código Code	Medida Size	Material Material	Longitud Length	Packing Packing
5009A000250	25 x 25 mm	Aluminio Aluminium	2,50 m	200 uds./pcs.

CAJAS INDIVISIBLES / INDIVISIBLE PACKING

**AL**  
ALUMINIO  
ANODIZADO  
ANODIZED  
ALUMINIUM



#### Medio Guardavivo Cartón Yeso **Aluminio**

##### Half Edge Aluminium Plasterboard Profile

Código Code	Medida Size	Material Material	Longitud Length	Packing Packing
5009A000125	27 x 12 mm	Aluminio Aluminium	2,50 m	100 uds./pcs.

CAJAS INDIVISIBLES / INDIVISIBLE PACKING

**AL**  
ALUMINIO  
ANODIZADO  
ANODIZED  
ALUMINIUM



■ Guard. Cartón Yeso **Ángulo Variable**  
Variable Angle Plasterboard Profile

■ Guard. Cartón Yeso **Flexible**  
Flexible Plasterboard Profile



**GALV**  
GALVANIZADO  
GALVANIZED

Guardavivo **Galvanizado** de Ángulo Variable Cartón Yeso  
Variable Angle Galvanized Plasterboard Profile

Código Code	Medida Size	Material Material	Longitud Length	Packing Packing
<b>50176000300</b>	30 x 30 mm	Galvanizado Galvanized	3,00 m	50 uds./pcs.

SE UTILIZA PARA LA PROTECCIÓN DE LAS ESQUINAS DE FALSA ESCUADRA.  
IT IS USED FOR THE PROTECTION OF FALSE SQUARE CORNERS.

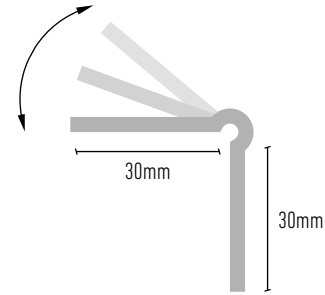

**GALV**  
GALVANIZADO  
GALVANIZED

Guardavivo **Galvanizado Flexible** Cartón Yeso  
Flexible Galvanized Plasterboard Profile

Código Code	Medida Size	Material Material	Longitud Length	Packing Packing
<b>50186000300</b>	30 x 30 mm	Galvanizado Galvanized	3,00 m	50 uds./pcs.

SE UTILIZA PARA LA PROTECCIÓN DE LAS ESQUINAS CURVAS DE CARTÓN YESO.  
IT IS USED FOR THE PROTECTION OF CURVED CORNERS OF PLASTERBOARD.

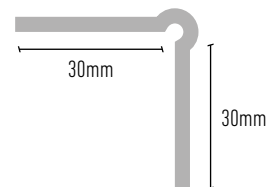



## Perfiles Cartón Yeso Aluminio Blanco

### White Aluminium Plasterboard Profiles

#### Perfil Cartón Yeso Aluminio Blanco Z Grande

##### White Aluminium Plastering Profile Big Z

Código Code	Color Colour	Longitud Length	Packing Packing
5011A012525	Blanco White	3,00 m	20 uds./pcs.

SE UTILIZA PARA LA CREACIÓN DE MARCOS, SUPERFICIES DISCONTÍNUAS, MOTIVOS EN RELIEVE, ETC.  
IT IS USED FOR THE CREATION OF FRAMES, DISCONTINUOUS SURFACES, RELIEF MOTIFS, ETC.

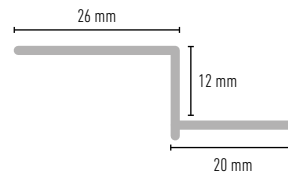

#### Perfil Cartón Yeso Aluminio Blanco Z Pequeña

##### White Aluminium Plastering Profile Small Z

Código Code	Color Colour	Longitud Length	Packing Packing
5011A012512	Blanco White	3,00 m	20 uds./pcs.

SE UTILIZA PARA LA CREACIÓN DE MARCOS, SUPERFICIES DISCONTÍNUAS, MOTIVOS EN RELIEVE, ETC.  
IT IS USED FOR THE CREATION OF FRAMES, DISCONTINUOUS SURFACES, RELIEF MOTIFS, ETC.

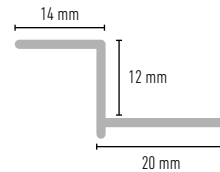

#### Perfil Cartón Yeso Aluminio Blanco L

##### White Aluminium Plastering Profile L

Código Code	Color Colour	Longitud Length	Packing Packing
5011A012500	Blanco White	3,00 m	40 uds./pcs.

SE UTILIZA PARA LA CREACIÓN DE MARCOS, SUPERFICIES DISCONTÍNUAS, MOTIVOS EN RELIEVE, ETC.  
IT IS USED FOR THE CREATION OF FRAMES, DISCONTINUOUS SURFACES, RELIEF MOTIFS, ETC.

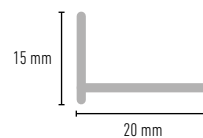



# COMPLEMENTOS para la CONSTRUCCIÓN

ACCESSORIES for  
CONSTRUCTION

ACCESSORIES FOR CONSTRUCTION / COMPLEMENTOS PARA LA CONSTRUCCIÓN



**YCR**

**Tubo Pasamuros**

PVC Tube

**Berenjeno**

Chamfer Strip

**Tubo Pasamuros Estriado PVC y accesorios**

PVC Tube and Accessories

Código Code	Medida Size	Acabado Finish	Longitud Length	Packing Packing
5101P000300	22 mm	Tubo estriado Grooved tube	3,00 m	30 uds./pcs.
5102P000001	22 mm	Cono para tubo Cone for tube	-	500 uds./pcs.
5102P000002	22 mm	Tapón Cap	-	1000 uds./pcs.

CAJAS INDIVISIBLES / INDIVISIBLE PACKING



**Berenjeno PVC Encofrar 20 / 25 / 30 mm**

PVC Chamfer Strip 20 / 25 / 30 mm

Código Code	Medida Size	Acabado Finish	Longitud Length	Packing Packing
5103P000020	20 mm	Pequeño Small	2,50 m	50 uds./pcs.
5103P000025	25 mm	Mediano Medium	2,50 m	50 uds./pcs.
5103P000030	30 mm	Grande Big	2,50 m	50 uds./pcs.

CAJAS INDIVISIBLES / INDIVISIBLE PACKING

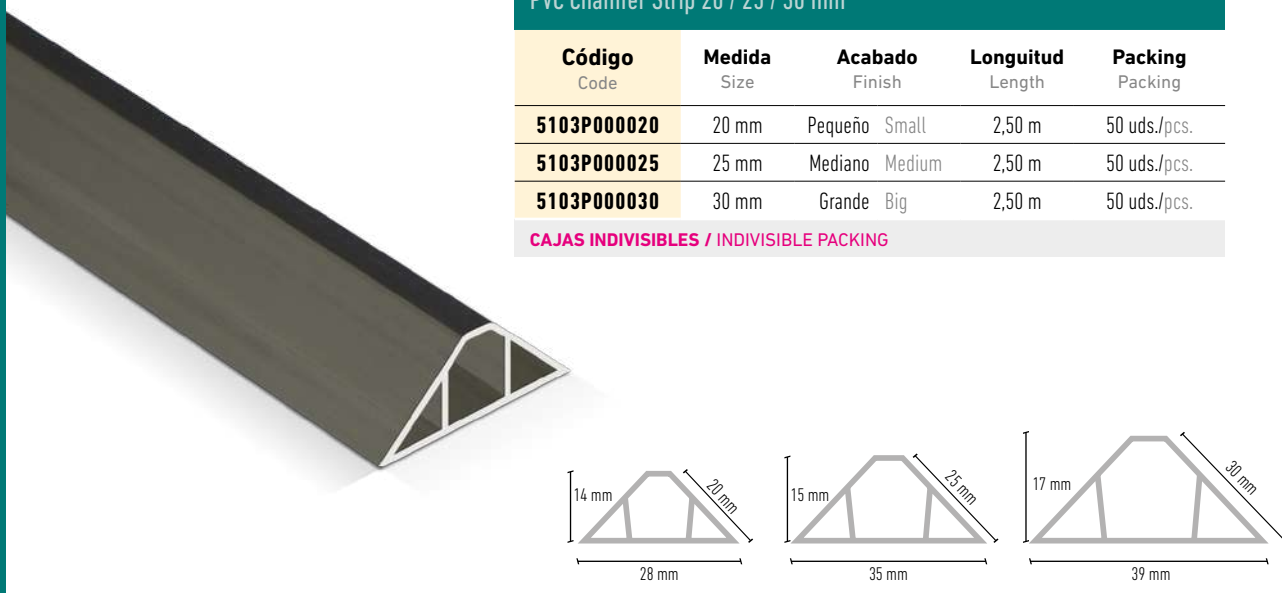



■ Armadura de Muro / Wall Reinforcement  
 ■ Fijaciones / Fixings

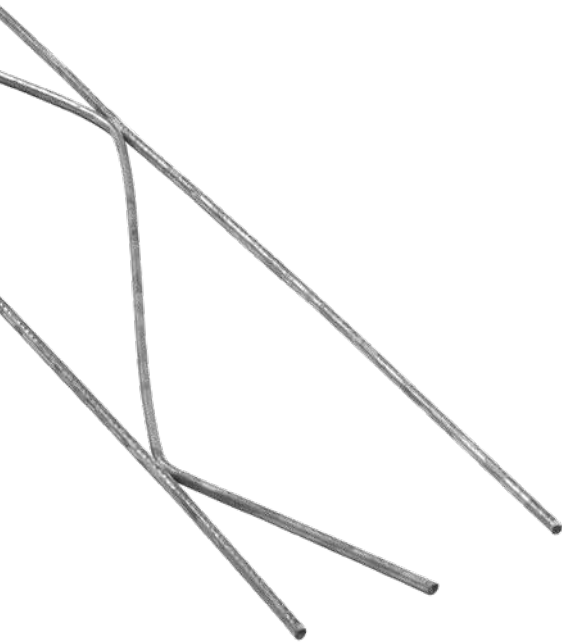

**Armadura para Muro Ø4 mm**  
 Wall Reinforcement Ø4 mm

**GALV**  
 GALVANIZADO  
 GALVANIZED

Código Code	Medida Size	Material Material	Longitud Length	Packing Packing
51046000050	50 mm	Galvanizado Galvanized	3,05 m	25 uds./pcs.
51046000080	80 mm	Galvanizado Galvanized	3,05 m	25 uds./pcs.
51046000100	100 mm	Galvanizado Galvanized	3,05 m	25 uds./pcs.
51046000150	150 mm	Galvanizado Galvanized	3,05 m	25 uds./pcs.
51046000200	200 mm	Galvanizado Galvanized	3,05 m	25 uds./pcs.
51046000250	250 mm	Galvanizado Galvanized	3,05 m	25 uds./pcs.

CAJAS INDIVISIBLES / INDIVISIBLE PACKING

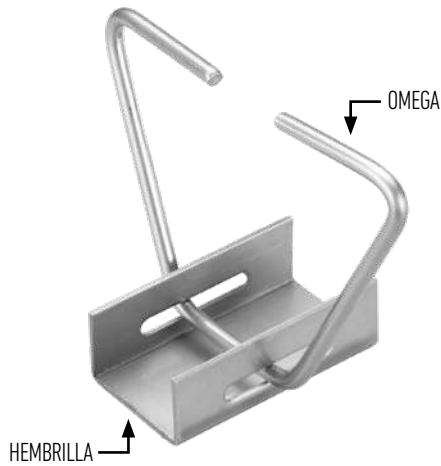

**Anclaje Omega Acero Inox**  
 Omega Stainless steel Anchorage

STAINLESS  
**STEEL**  
 AISI 304

Código Code	Descripción Description	Medida Size	Material Material	Packing Packing
51111003664	Hembrilla	36 x 64 mm	Acero Inox Stainless steel	100 uds./pcs.
51121001175	Omega 1	116 x 75 mm	Acero Inox Stainless steel	100 uds./pcs.
51121001612	Omega 2	166 x 125 mm	Acero Inox Stainless steel	100 uds./pcs.
51121002117	Omega 3	216 x 175 mm	Acero Inox Stainless steel	100 uds./pcs.
51121003625	Omega 4	366 x 25 mm	Acero Inox Stainless steel	100 uds./pcs.

**Anclaje Fijo Lateral Acero Inox**  
 Lateral Fixed Stainless Steel Bracket

STAINLESS  
**STEEL**  
 AISI 304



Código Code	Medida Size	Material Material	Packing Packing
51121000162	162 mm	Acero Inox Stainless steel	100 uds./pcs.

**Anclaje Fijo Frontal Acero Inox**  
 Frontal Fixed Stainless Steel Bracket

STAINLESS  
**STEEL**  
 AISI 304



Código Code	Medida Size	Material Material	Packing Packing
51121000108	108 mm	Acero Inox Stainless steel	100 uds./pcs.
51121000150	150 mm	Acero Inox Stainless steel	100 uds./pcs.



**Anclaje Dilatación Acero Inox**  
 Expansion Stainless Steel Bracket

STAINLESS  
**STEEL**  
 AISI 304

Código Code	Medida Size	Material Material	Packing Packing
51121000000	-	Acero Inox Stainless steel	100 uds./pcs.



**YCR**

■ Tacos Fijación **Standard**  
Standard Fixing Plugs

■ Tacos Fijación **Lana de Roca**  
Rockwool Fixing Plugs



**Taco Expansión Standard**  
Standard Fixing Plugs

Código Code	Medida Size	Ø Diámetro Ø Diameter	Cabeza Head	Packing Packing
<b>5105P000070</b>	50 x 70 mm	Ø 10 mm	Ø 50 mm	250 uds./pcs.
<b>5105P000090</b>	50 x 90 mm	Ø 10 mm	Ø 50 mm	250 uds./pcs.
<b>5105P000110</b>	50 x 110 mm	Ø 10 mm	Ø 50 mm	250 uds./pcs.
<b>5105P000130</b>	50 x 130 mm	Ø 10 mm	Ø 50 mm	250 uds./pcs.
<b>5105P000150</b>	50 x 150 mm	Ø 10 mm	Ø 50 mm	250 uds./pcs.
<b>5105P000180</b>	50 x 180 mm	Ø 10 mm	Ø 50 mm	250 uds./pcs.
<b>5105P000200</b>	50 x 200 mm	Ø 10 mm	Ø 50 mm	250 uds./pcs.

CAJAS INDIVISIBLES / INDIVISIBLE PACKING



**Arandela para Taco LANA DE ROCA**  
Rockwool Fixing Plugs

Código Code	Cabeza Head	Packing Packing
<b>5105P000001</b>	Ø 90 mm	250 uds./pcs.

CAJAS INDIVISIBLES / INDIVISIBLE PACKING

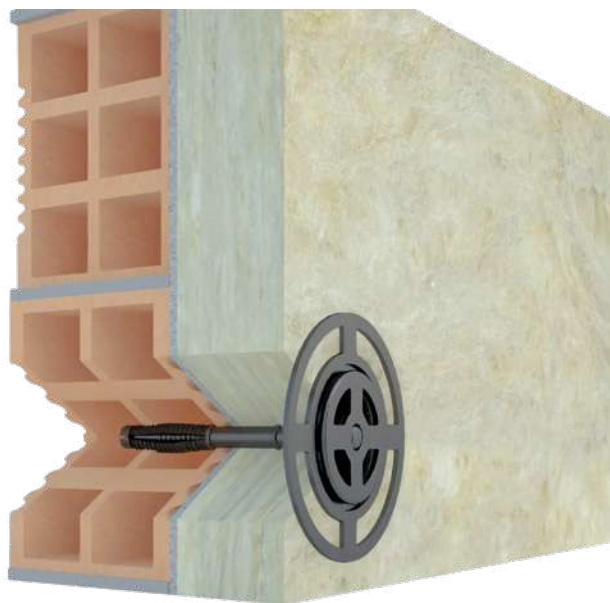



## Complementos Encofrado

### Formworks Accessories Guard Rails



#### Guardacuerpos Redondo

##### Round Safety Guard Rail

Código Code	Medida Size	Material Material	Packing Packing
5108P000001	Ø 40 mm	PVC PVC	200 uds./pcs.

CAJAS INDIVISIBLES / INDIVISIBLE PACKING



#### Base Orca

##### Orca Base

Código Code	Medida Size	Material Material	Packing Packing
5109P000001	65 x 90 mm	PVC PVC	48 uds./pcs.

CAJAS INDIVISIBLES / INDIVISIBLE PACKING



#### Seta Cubre Varillas Universales

##### Universal Iron Rod Cover

Código Code	Medida Size	Material Material	Packing Packing
5110P000001	UNIVERSAL	Polipropileno Polypropylene	250 uds./pcs.

CAJAS INDIVISIBLES / INDIVISIBLE PACKING



#### Cóndor

##### Condor

Código Code	Medida Size	Material Material	Packing Packing
5106P000020	20 mm	PVC PVC	500 uds./pcs.
5106P000030	30 mm	PVC PVC	500 uds./pcs.
5106P000040	40 mm	PVC PVC	500 uds./pcs.
5106P000050	50 mm	PVC PVC	500 uds./pcs.

CAJAS INDIVISIBLES / INDIVISIBLE PACKING



#### Timón

##### Rudder

Código Code	Medida Size	Material Material	Packing Packing
5107P000020	20 mm	PVC PVC	1000 uds./pcs.
5107P000025	25 mm	PVC PVC	500 uds./pcs.
5107P000030	30 mm	PVC PVC	500 uds./pcs.
5107P000035	35 mm	PVC PVC	200 uds./pcs.
5107P000040	40 mm	PVC PVC	125 uds./pcs.
5107P000045	50 mm	PVC PVC	100 uds./pcs.

CAJAS INDIVISIBLES / INDIVISIBLE PACKING



**YCR**

**Rastrel PVC**

PVC under Tile Batten

**Apoyaondas Polipropileno**

Waves Spacers Polypropylene

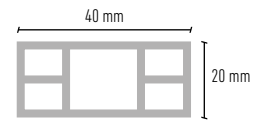

**Rastrel PVC Bajo Teja**

PVC under Tile Batten

Código Code	Medida Size	Material Material	Longitud Length	Packing Packing
<b>5301P014020</b>	40 x 20 mm	PVC PVC	2,00 m	10 uds./pcs.

**Apoyaondas Polipropileno**

Waves Spacers Polypropylene



GRAN ONDA  
BIG WAVE

MINI ONDA  
SMALL WAVE

Código Code	Altura Height	Material Material	Longitud Length	Packing Packing
<b>5302P010018</b>	18 mm	PP PP	Mini-Onda Small Wave	250 uds./pcs.
<b>5302P010050</b>	50 mm	PP PP	Gran-Onda Big Wave	250 uds./pcs.

CAJAS INDIVISIBLES / INDIVISIBLE PACKING

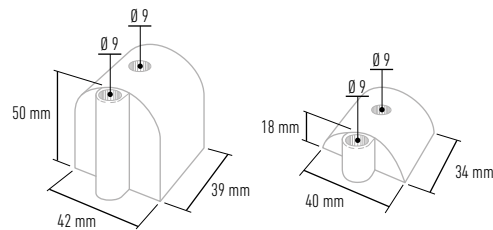

**STAINLESS  
STEEL  
AISI 304**

■ **Disuasor Acero Inox Aisi 304**

Stainless Steel Deterrent

■ **Disuasor Acero Inox + Policarbonato**

Stainless Steel + Polycarbonate Deterrent

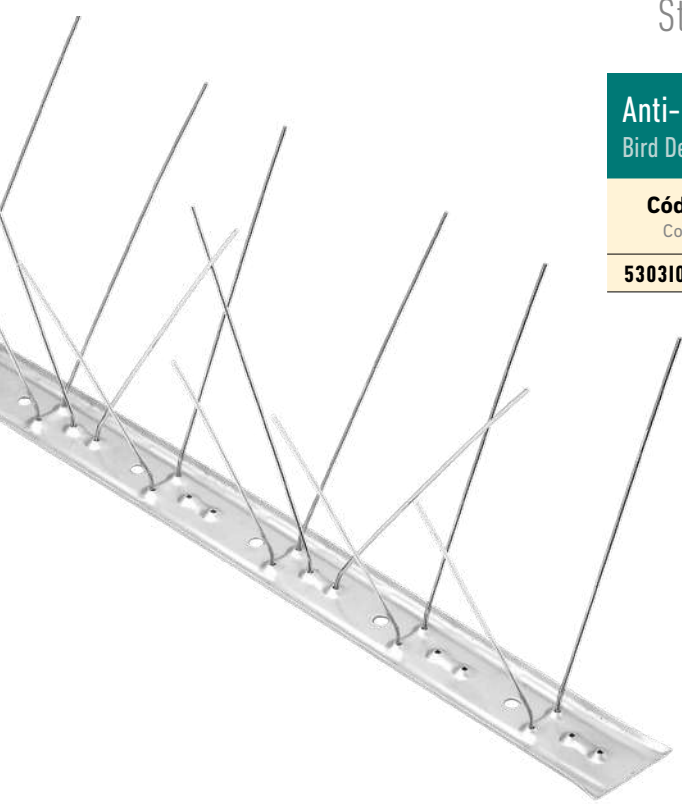

**Anti-pájaros Acero Inox + Puas Inox x 100 cm**

Bird Deterrent Stainless Steel + Stainless Steel Skewrs x 100 cm

Código Code	Altura Height	Material Material	Longitud Length	Packing Packing
<b>53031000100</b>	103 mm	Acero Inox Stainless Steel	100 cm	25 uds./pcs.

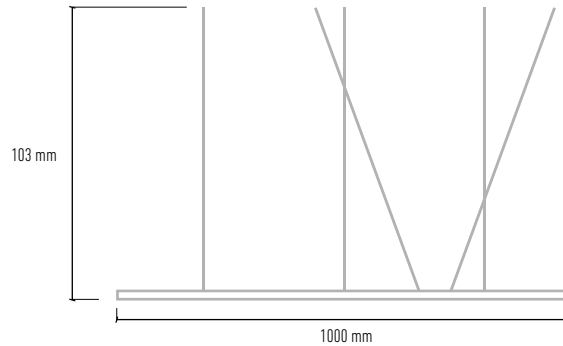

**Anti-pájaros Policarbonato + Puas Inox x 50 cm**

Bird Deterrent Polycarbonate + Stainless Steel Skewers x 50 cm

Código Code	Altura Height	Material Material	Longitud Length	Packing Packing
<b>53031000050</b>	105 mm	Acero Inox + Policarbonato Stainless Steel + Polycarbonate	50 cm	50 uds./pcs.

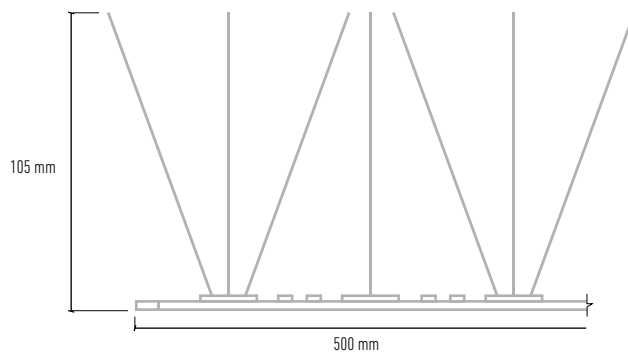

Cintas Adhesivas  
**Industriales**  
Adhesives Tapes



Cintas Adhesivas  
**Antideslizantes**  
Anti-Slip  
Adhesives Tapes



**Americana**  
American

Código Code	Ancho Width	Longitud Length	Color Colour	Packing Packing
0702P035010	50 mm	10 m	Gris Grey	10 uds./pcs.
0702P035025	50 mm	25 m	Gris Grey	10 uds./pcs.

**Aluminio**  
Aluminium

Código Code	Ancho Width	Longitud Length	Material Material	Packing Packing
0702A025050	50 mm	50 m	Aluminio Aluminium	10 uds./pcs.

**Doble Cara**  
Double Sided

Código Code	Ancho Width	Longitud Length	Color Colour	Packing Packing
0702P005010	50 mm	10 m	Transparente Transparent	10 uds./pcs.
0702P005025	50 mm	25 m	Transparente Transparent	10 uds./pcs.

**Antideslizante Transparente**  
Transparent Anti-Slip

Código Code	Ancho Width	Longitud Length	Color Colour	Packing Packing
0702P000255	25 mm	5 m	Transparente Transparent	10 uds./pcs.

**Antideslizante Fluorescente**  
Fluorescent Anti-Slip

Código Code	Ancho Width	Longitud Length	Color Colour	Packing Packing
0702P980505	50 mm	5 m	Fluorescente Fluorescent	10 uds./pcs.

**Bicolor Antideslizante Negro/Amarillo**  
Bicolour Anti-Slip Black / Yellow

Código Code	Ancho Width	Longitud Length	Color Colour	Packing Packing
0702P990255	25 mm	5 m	Negro/Amarillo Black/Yellow	10 uds./pcs.

**Antideslizante Luminiscente**  
Luminiscent Anti-Slip

Código Code	Ancho Width	Longitud Length	Color Colour	Packing Packing
0702P972505	25 mm	5 m	Luminiscente Luminiscent	10 uds./pcs.

**Antideslizante Negra**  
Black Anti-Slip

Código Code	Ancho Width	Longitud Length	Color Colour	Packing Packing
0702P180255	25 mm	5 m	Negro Black	10 uds./pcs.
0702P180505	50 mm	5 m	Negro Black	10 uds./pcs.



# MALLAS y LÁMINAS

## MEMBRANES & MESH





MADE IN EUROPE CE



### Lámina WaterDry®

WaterDry® Membrane

Código Code	Ancho Width	Longitud Length	Acabado Finish	Gramaje Weight	m <sup>2</sup> m <sup>2</sup>
5403P130010	1 m	10 m	Rojo Red	300 gr/m <sup>2</sup>	10 m <sup>2</sup>
5403P130030	1 m	30 m	Rojo Red	300 gr/m <sup>2</sup>	30 m <sup>2</sup>
5403P130015	1,5 m	20 m	Rojo Red	300 gr/m <sup>2</sup>	30 m <sup>2</sup>
5403P130020	2 m	20 m	Rojo Red	300 gr/m <sup>2</sup>	40 m <sup>2</sup>

IDEAL PARA IMPERMEABILIZAR DUCHAS, TERRAZAS, PISCINAS Y CUBIERTAS, MEDIANTE FIJACIÓN CON CEMENTO COLA.  
IDEAL FOR WATERPROOFING SHOWERS, TERRACES, SWIMMING POOLS AND ROOFS, BY FIXING WITH SEALANT ADHESIVE.



YouTube  
WaterDry®

- INSTALACIÓN
- INSTALLATION

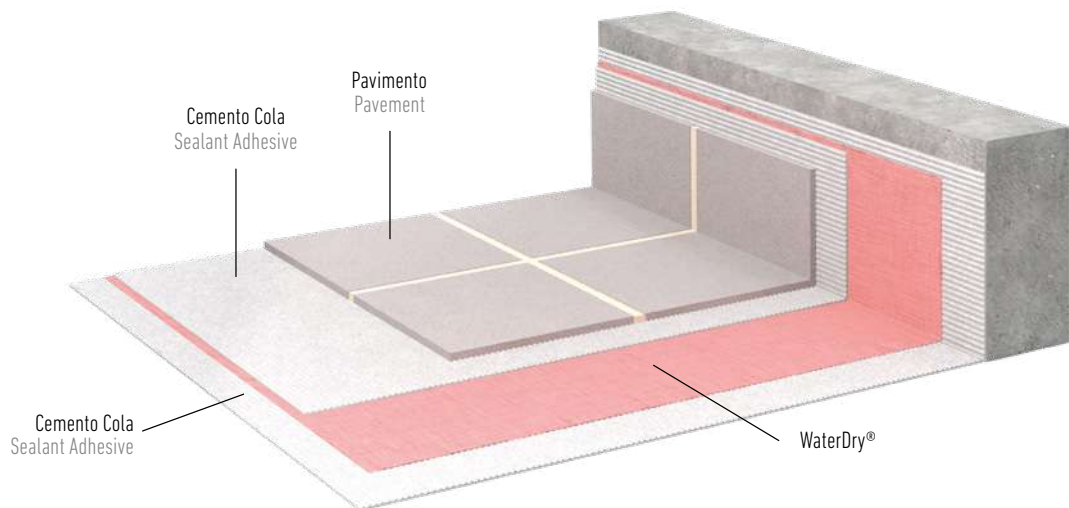



**Complementos WaterDry®**  
WaterDry® Accessories

**Complementos Lámina WaterDry®**  
WaterDry® Membrane Accessories

Código Code	Descripción Description	Packing Packing
5404P130001	Esquina interior WaterDry® Internal Corner	4 uds./pcs.
5404P130002	Esquina exterior WaterDry® External Corner	4 uds./pcs.
5404P130003	Banda de 12,5 cm x 5 m WaterDry® Shower Band	4 uds./pcs.

CAJAS INDIVISIBLES / INDIVISIBLE PACKING



Esquina Interior  
Internal Corner

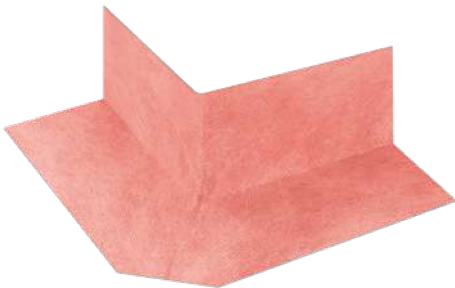

Esquina Exterior  
External Corner

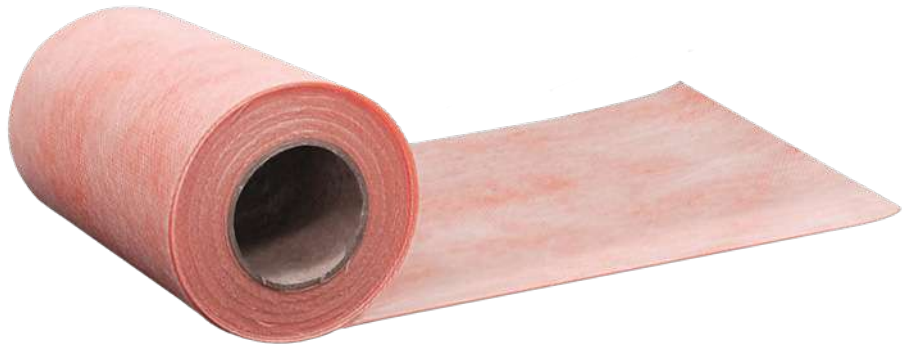

Banda Impermeable  
Shower Band

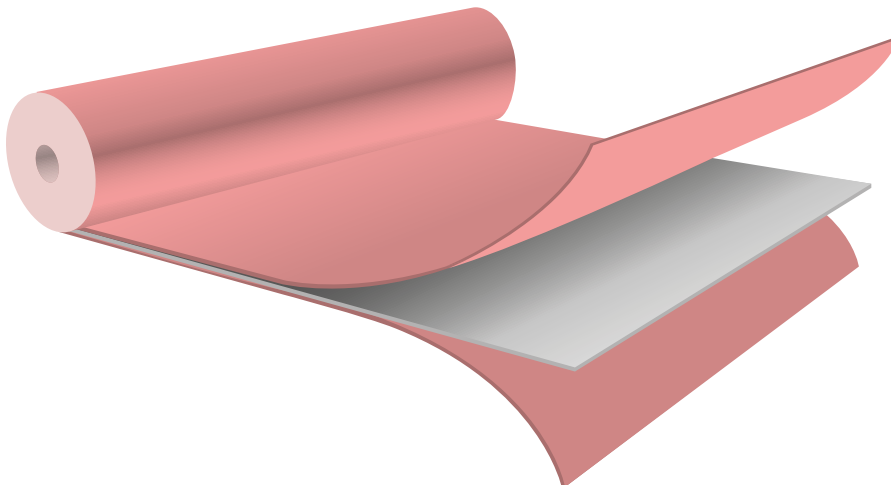

- Polipropileno  
Polypropylene
- Lámina EVAC  
EVAC Membrane
- Polipropileno  
Polypropylene

**YCR**

**Unrift Dry®**



**Lámina Impermeable Desolidarizante YCR UNRIFT DRY®**  
 Uncoupling Membrane Unrift Dry®

Código Code	Medida Size	Color Colour	Gramaje Weight	m <sup>2</sup> m <sup>2</sup>
5403P160030	1 x 30 m	Rojo Red	600 gr/m <sup>2</sup>	30 m <sup>2</sup>

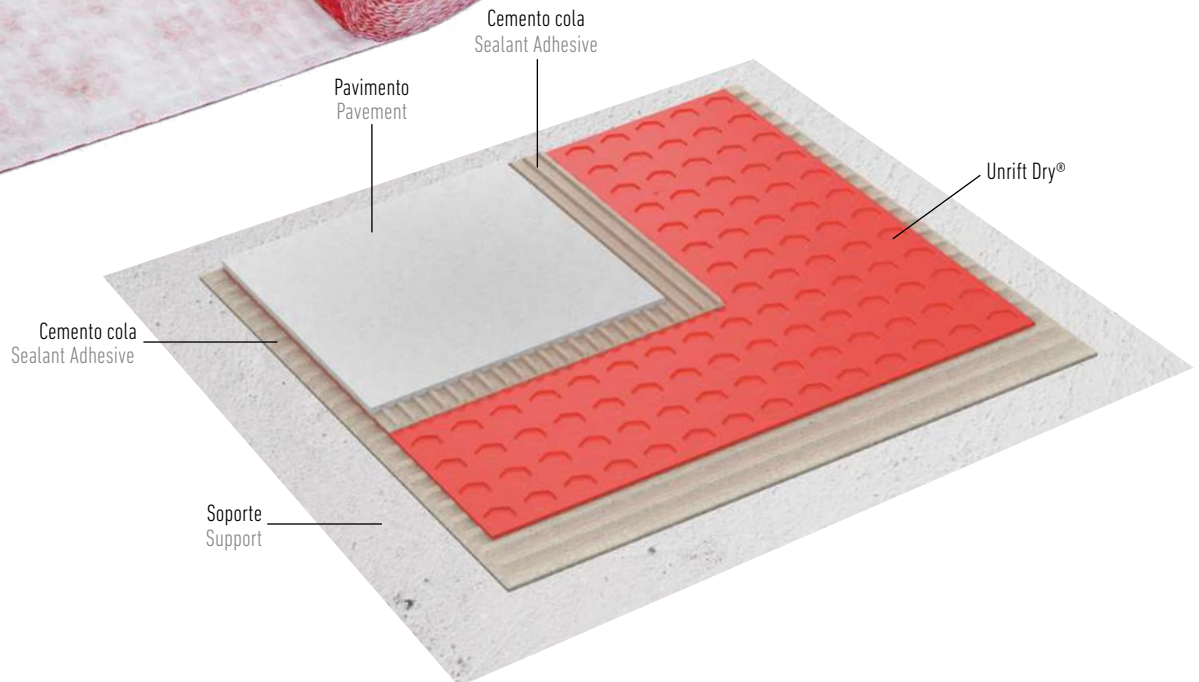
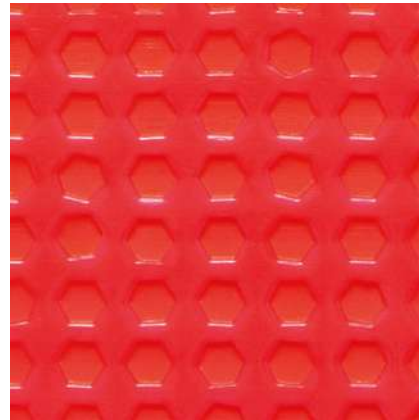

■ **Mat Fibra de Vidrio**

Fiberglass Mat

■ **Malla Velo**

Fiberglass Velo



**Mat Fibra de Vidrio 150 / 300 grs**

Fiberglass Mat 150 / 130 grs

Código Code	m <sup>2</sup> m <sup>2</sup>	Material Material	Gramaje Weight	Packing Packing
<b>5404V011515</b>	15 m <sup>2</sup>	Fibra de Vidrio Fiberglass	150 gr/m <sup>2</sup>	16 Rollos/Rolls
<b>5404V011525</b>	25 m <sup>2</sup>	Fibra de Vidrio Fiberglass	150 gr/m <sup>2</sup>	9 Rollos/Rolls
<b>5404V011550</b>	50 m <sup>2</sup>	Fibra de Vidrio Fiberglass	150 gr/m <sup>2</sup>	4 Rollos/Rolls
<b>5404V013010</b>	10 m <sup>2</sup>	Fibra de Vidrio Fiberglass	300 gr/m <sup>2</sup>	9 Rollos/Rolls
<b>5404V013025</b>	25 m <sup>2</sup>	Fibra de Vidrio Fiberglass	300 gr/m <sup>2</sup>	4 Rollos/Rolls
<b>5404V013050</b>	50 m <sup>2</sup>	Fibra de Vidrio Fiberglass	300 gr/m <sup>2</sup>	4 Rollos/Rolls

**CONSULTAR PARA OTROS GRAMAJES Y MEDIDAS. / PRODUCTO DESTINADO AL REFUERZO DE PINTURA DE CAUCHO.**  
OTHER WEIGHTS AND MEASURES AVAILABLE. / PRODUCT FOR REINFORCING RUBBER PAINT.



**Malla Velo 50 gr/m<sup>2</sup>**

Fiberglass Velo 50 gr/sq. m

Código Code	Medida Size	Material Material	Color Colour	Gramaje Weight	Ud./ Palet Pcs./Pallet
<b>5405V010050</b>	1 x 50 m	Fibra de Vidrio Fiberglass	Blanco White	50 gr/m <sup>2</sup>	49 uds./pcs.

**PRODUCTO DESTINADO AL REFUERZO DE PINTURA DE CAUCHO.**  
PRODUCT FOR REINFORCING RUBBER PAINT.



## Mallas de Refuerzo / Reinforcing Mesh

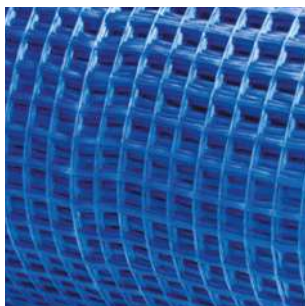

**Malla Mortero 90 gr**  
Blue Mortar Mesh 90 gr

Código Code	Medida Size	Material Material	Color Colour	Gramaje Weight	Ud./ Palet Pcs./Pallet
5401V130100	1 x 50 m	Fibra de Vidrio Fiberglass	Azul Blue	90 gr/m <sup>2</sup>	35 uds./pcs.
5401V010090	1 x 50 m	Fibra de Vidrio Fiberglass	Blanco White	90 gr/m <sup>2</sup>	35 uds./pcs.

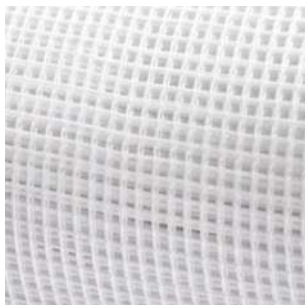

**Malla Yeso Blanca 75 gr**  
White Plaster Mesh 75 gr

Código Code	Medida Size	Material Material	Color Colour	Gramaje Weight	Ud./ Palet Pcs./Pallet
5402V010075	1 x 50 m	Fibra de Vidrio Fiberglass	Blanco White	75 gr/m <sup>2</sup>	50 uds./pcs.



**Malla Pintura 48 gr**  
Painting Mesh 48 gr

Código Code	Medida Size	Material Material	Gramaje Weight	Ud./ Palet Pcs./Pallet
5403V010048	1 x 50 m	Fibra de Vidrio Fiberglass	48 gr/m <sup>2</sup>	82 uds./pcs.

**PRODUCTO DESTINADO AL REFUERZO DE PINTURA DE CAUCHO.**  
PRODUCT DESIGNED TO REINFORCE RUBBER PAINT.



## Mallas Especiales / Special Mesh



**Malla Pavimento 40 x 40 mm**  
Pavement Mesh 40 x 40 mm

Código Code	Medida Size	Material Material	Color Colour	Gramaje Weight	Ud./ Palet Pcs./Pallet
<b>5406V520140</b>	1 x 50 m	Fibra de Vidrio Fiberglass	Verde Green	140 gr/m <sup>2</sup>	18 uds./pcs.

Perfecto para reforzos en losas de hormigón y mortero que no requieran refuerzo estructural. Indicado también como refuerzo en dilataciones en la colocación de suelo radiante. / Perfect for reinforcements in concrete and mortar slabs that do not require structural reinforcement. Also indicated as reinforcement in expansions in the placement of underfloor heating.

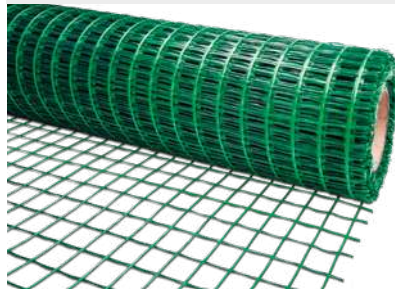

**Malla Mortero 10 x 10 mm Blanca 110 gr**  
White Mortar Mesh 10 x 10 mm / 110 gr

Código Code	Medida Size	Material Material	Color Colour	Gramaje Weight	Ud./ Palet Pcs./Pallet
<b>5401V010110</b>	1 x 50 m	Fibra de Vidrio Fiberglass	Blanco White	110 gr/m <sup>2</sup>	30 uds./pcs.



**Malla Aislamiento Térmico 160 gr (SATE)**  
Thermal Insulation Mesh 160 gr (SATE)

Código Code	Medida Size	Material Material	Color Colour	Gramaje Weight	Ud./ Palet Pcs./Pallet
<b>5402V010160</b>	1 x 50 m	Fibra de Vidrio Fiberglass	Blanco White	160 gr/m <sup>2</sup>	30 uds./pcs.



- Fibra **Polipropileno** / Polypropylene Fiber
- Fibra de **Vidrio** / Fiberglass
- Resina Puente de Unión / Resins



### Fibra Polipropileno Polypropylene Fiber

Código Code	Peso Weight	Material material	Packing Packing
<b>5409F010600</b>	600 gr	Polipropileno Polypropylene	30 Bolsas/Bags
<b>Ideal como refuerzo de hormigón y cemento. / Ideal as reinforcement of concrete and cement.</b>			
<b>CAJAS INDIVISIBLES / INDIVISIBLE PACKING</b>			



### Fibra de Vidrio Fiberglass

Código Code	Peso Weight	Material material	Packing Packing
<b>5410V011000</b>	1000 gr	Fibra de Vidrio Fiberglass	17 Bolsas/Bags
<b>CAJAS INDIVISIBLES / INDIVISIBLE PACKING</b>			



### Resina Puente de Unión 1 / 5 / 25 L Resins 1 / 5 / 25 L

Código Code	Peso Weight	Packing Packing
<b>6102Q010001</b>	1 L	8 uds./pcs.
<b>6102Q010005</b>	5 L	4 uds./pcs.
<b>6102Q010025</b>	25 L	6 uds./pcs.

**Plásticos Solera**  
Foundation Plastic



**Plástico Solera Galga**  
Foundation Plastics Feeler Gauge

Código Code	Medida Size	Color Colour	Galga Feeler Gauge	Rollos/Palet Rolls/Pallet
<b>5408P184200</b>	4 x 50 m	Negro Black	400	39 Rollos/Rolls
<b>5408P186200</b>	4 x 50 m	Negro Black	600	33 Rollos/Rolls
<b>5408P504200</b>	4 x 50 m	Transparente Transparent	400	39 Rollos/Rolls
<b>5408P506200</b>	4 x 50 m	Transparente Transparent	600	33 Rollos/Rolls

## Mallas Construcción

### Construction Mesh

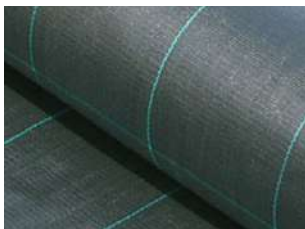

#### Malla Antihierba

Anti-Weed Mesh

Código Code	Medida Size	Material Material	Color Colour	Gramaje Weight	Packing
5603P180100	1 x 100 m	Polipropileno Polypropylene	Negro Black	105 gr/m <sup>2</sup>	1 ud./pc.
5603P180200	2 x 100 m	Polipropileno Polypropylene	Negro Black	105 gr/m <sup>2</sup>	1 ud./pc.



#### Malla Andamio Anti-UV

Scaffold Mesh Anti-UV

Código Code	Medida Size	Material Material	Color Colour	Gramaje Weight	Packing
5601P520320	3 x 20 m	Polietileno Anti-UV Polyethylene Anti-UV	Verde Green	58 gr/m <sup>2</sup>	1 ud./pc.
5601P520510	5 x 10 m	Polietileno Anti-UV Polyethylene Anti-UV	Verde Green	58 gr/m <sup>2</sup>	1 ud./pc.



#### Malla Bicolor Ocultación 90% Anti-UV

Bicolour Concealment 90% Anti-UV

Código Code	Medida Size	Material Material	Color Colour	Gramaje Weight	Packing
5602P180100	2 x 50 m	Polietileno Anti-UV Polyethylene Anti-UV	Negro+Rojo Black+Red	100 gr/m <sup>2</sup>	1 ud./pc.
5602P180006	1,9 x 3,6 m	Polietileno Anti-UV Polyethylene Anti-UV	Negro+Rojo Black+Red	100 gr/m <sup>2</sup>	1 ud./pc.



#### Malla Ocultación 90% Anti-UV

Concealment Mesh

Código Code	Medida Size	Material Material	Color Colour	Gramaje Weight	Packing
5602P520100	2 x 50 m	Polietileno Anti-UV Polyethylene Anti-UV	Verde Osc. Dark Green	100 gr/m <sup>2</sup>	1 ud./pc.
5602P520015	1,5 x 10 m	Polietileno Anti-UV Polyethylene Anti-UV	Verde Osc. Dark Green	100 gr/m <sup>2</sup>	1 ud./pc.
5602P520050	1 x 50 m	Polietileno Anti-UV Polyethylene Anti-UV	Verde Osc. Dark Green	100 gr/m <sup>2</sup>	1 ud./pc.



#### Malla Señalización Naranja Anti-UV

Orange Signaling Anti-UV Mesh

Código Code	Medida Size	Material Material	Color Colour	Gramaje Weight	Packing
5604P320050	1 x 50 m	Polietileno Anti-UV Polyethylene Anti-UV	Naranja Orange	80 gr/m <sup>2</sup>	1 ud./pc.



# REGISTROS



CERTIFICADO  
EN 200.000  
APERTURAS  
UNE EN 1191:2000

CERTIFICADO  
RESISTENCIA A  
LA CORROSIÓN  
48h DE EXPOSICIÓN

CERTIFICADO  
RESISTENCIA A  
LA TRACCIÓN  
AXIAL  
3090 NEWTON

## ■ Armazones para Tabique Revocado

Door Frames Brickwall

## ■ Armazones para Tabique Cartón Yeso

Door Frames Plasterboard Wall



Tabique Revocado Brickwall		Acabado/Finish 9 cm	Acabado/Finish 10,5 cm
Altura Paso libre Clear passage height	Ancho Paso libre Clear passage width	Tabique 7 cm Brick 7 cm	Tabique 9 cm Brick 9 cm
203 cm	60 cm	58016006309	58016006311
	70 cm	58016007309	58016007311
	80 cm	58016008309	58016008311
	90 cm	58016009309	58016009311
	100 cm	58016001309	58016001311
	110 cm	58016001130	58016001135
	120 cm	58016001230	58016001235

**ALTURA 210 cm PASO LIBRE CONSULTAR**  
210 cm CLEAR PASSAGE UPON REQUEST



Tabique Cartón Yeso Plasterboard Wall		Acabado/Finish 10 cm
Altura Paso libre Clear passage height	Ancho Paso libre Clear passage width	Código Code
203 cm	60 cm	58026006203
	70 cm	58026007203
	80 cm	58026008203
	90 cm	58026009203
	100 cm	58026001003
	110 cm	58026001103
	120 cm	58026001203

**ALTURA 210 cm PASO LIBRE CONSULTAR**  
210 cm CLEAR PASSAGE UPON REQUEST

### Complementos Armazones

Complements Door Frames

Código	Descripción	Description
58031000000	Pinza puerta cristal	Glass door clamp
5804P000000	Freno ABS para armazón	ABS brake for frame
5804P000001	Recambio rodamiento armazón	Replacement bearing frame
5805G006309	Suplemento armazón doble 60 x 90 / Cartón Yeso	Double frame supplement 60 x 90 / Plasterboard
5805G007309	Suplemento armazón doble 70 x 90 / Cartón Yeso	Double frame supplement 70 x 90 / Plasterboard
5805G000000	Suplemento armazón doble 80 x 90 / Cartón Yeso	Double frame supplement 80 x 90 / Plasterboard
5805G006311	Suplemento armazón doble 60 x 105	Double frame supplement 60 x 105
5805G007311	Suplemento armazón doble 70 x 105	Double frame supplement 70 x 105
5805G008311	Suplemento armazón doble 80 x 105	Double frame supplement 80 x 105

**FABRICACIÓN  
A MEDIDA  
Altura MAX.  
3,00 m  
Ancho MAX.  
2,50 m**



## Registros de Fachada

### Doors for Counters

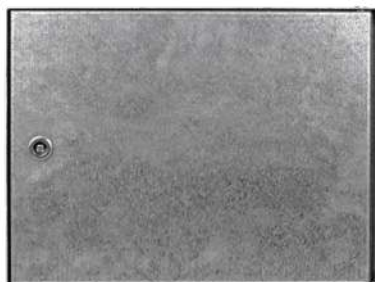

#### Registro de Fachada Galvanizado Liso

Galvanized Smooth Door for Counters

Código Code	Medida Size	Material Material		Espesor Thickness
59016004030	40 x 30 cm	Galvanizado	Galvanized	25 mm
59016004050	40 x 50 cm	Galvanizado	Galvanized	25 mm
59016005040	50 x 40 cm	Galvanizado	Galvanized	25 mm
59016000001	Registro Liso Galvanizado Medida Especial m <sup>2</sup> / sq. m.			

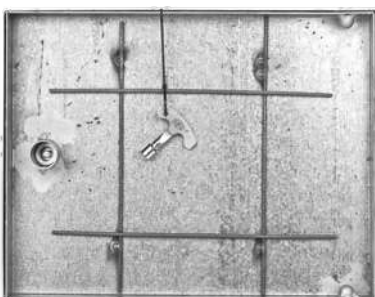

#### Registro de Fachada Panelable Galvanizado

Galvanized Refillable Door for Counters

Código Code	Medida Size	Material Material		Espesor Thickness
59046004030	40 x 30 cm	Galvanizado	Galvanized	58 mm
59046004050	40 x 50 cm	Galvanizado	Galvanized	58 mm
59046005040	50 x 40 cm	Galvanizado	Galvanized	58 mm
59046000001	Registro Panelable Medida Especial m <sup>2</sup> / sq. m.			

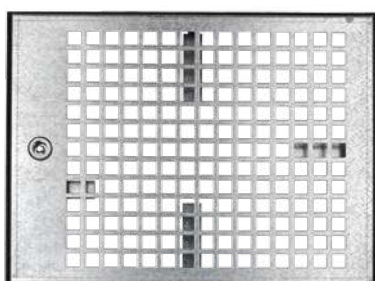

#### Registro de Fachada Galvanizado Troquelado

Galvanized Perforated Door for Counters

Código Code	Medida Size	Material Material		Espesor Thickness
59026004030	40 x 30 cm	Galvanizado	Galvanized	25 mm
59026004050	40 x 50 cm	Galvanizado	Galvanized	25 mm
59026005040	50 x 40 cm	Galvanizado	Galvanized	25 mm
59026000001	Registro Troquelado Medida Especial m <sup>2</sup> / sq. m.			



TRIÁNGULO

CUADRADO

#### Bombín y Llave

Locks and Keys

Código Code	Descripción Description		
59116000003	Bombín Triángulo para registro	Triangle bowler	
59116000001	Llave Triángulo para registro	Triangle key	
59116000004	Bombín Cuadrado para registro	Square bowler	
59116000002	Llave Cuadrado para registro	Square key	

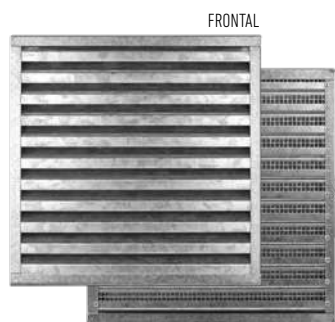

FRONTAL

TRASERA

#### Persiana de Ventilación Galvanizada

Galvanized Ventilation Grill

Código Code	Medida Size	Material Material		Espesor Thickness
59036003030	30 x 30 cm	Galvanizado	Galvanized	35 mm
59036004020	40 x 20 cm	Galvanizado	Galvanized	35 mm
59036004040	40 x 40 cm	Galvanizado	Galvanized	35 mm
59036005050	50 x 50 cm	Galvanizado	Galvanized	35 mm



YCR

## Registros de Suelo

### Floor Cap



### Tapas + Marco Rellenables Reforzadas Galvanizadas

#### Galvanized Refillable Lid

Código Code	Medida Size	Material Material		Espesor Thickness
<b>5905G003030</b>	30 x 30 cm	Galvanizado	Galvanized	42 mm
<b>5905G004040</b>	40 x 40 cm	Galvanizado	Galvanized	42 mm
<b>5905G005050</b>	50 x 50 cm	Galvanizado	Galvanized	42 mm
<b>5905G006060</b>	60 x 60 cm	Galvanizado	Galvanized	42 mm
<b>5905G000001</b>	Tapa Rellenable Galvanizada Medida Especial m <sup>2</sup> / sq. m.			



### Tapas + Marco Rellenables Galvanizadas Herméticas

#### Galvanized Airtight Refillable Lid

Código Code	Medida Size	Material Material		Espesor Thickness
<b>5906G003030</b>	30 x 30 cm	Galvanizado	Galvanized	45 mm
<b>5906G004040</b>	40 x 40 cm	Galvanizado	Galvanized	45 mm
<b>5906G005050</b>	50 x 50 cm	Galvanizado	Galvanized	45 mm
<b>5906G006060</b>	60 x 60 cm	Galvanizado	Galvanized	45 mm
<b>5906G000001</b>	Tapa Rellenable Galvanizada Hermética Medida Especial m <sup>2</sup> / sq. m.			

**JUNTA DE NEOPRENO DE 3 X 20 MM. / FIJACIÓN AL MARCO CON TORNILLOS ALLEN.**  
**3 X 20 MM NEOPRENE GASKET. / FIXING TO THE FRAME WITH ALLEN SCREWS.**

# Registros de Contador

## Doors for Counters



### Registro con Rejilla Puerta Contadores

#### Galvanized Door with Window

Código Code	Medida Size
5907G007014	74 x 144 cm
5907G007016	74 x 164 cm

LA REJILLA INCLUYE METRAQUILATO DE PROTECCIÓN / THE GRID INCLUDES PROTECTIVE METHACRYLATE

Medidas de hueco de obra:  
En caso de enrasar el marco añadir 5 cm de alto y ancho al hueco de obra  
Construction opening measurements:  
If the frame is flush, add 5 cm in height and width to the work opening

### Registro Ventilado

#### Smooth Galvanized Door

Código Code	Medida Size
5908G007010	74 x 104 cm
5908G007012	74 x 124 cm
5908G007014	74 x 144 cm
5908G007016	74 x 164 cm

Medidas de hueco de obra:  
En caso de enrasar el marco añadir 5 cm de alto y ancho al hueco de obra  
Construction opening measurements:  
If the frame is flush, add 5 cm in height and width to the work opening



### Registro Panelable

#### Refillable Galvanized Door

Código Code	Medida Size
5909G007012	81 x 129 cm
5909G007014	81 x 149 cm
5909G007016	81 x 169 cm

MEDIDAS DE HUECO DE OBRA / CONSTRUCTION OPENING MEASUREMENTS

### Registro Panelable con Rejilla Puerta Contador

#### Refillable Galvanized Door with Window

Código Code	Medida Size
5910G007016	81 x 169 cm

LA REJILLA INCLUYE METRAQUILATO DE PROTECCIÓN / THE GRID INCLUDES PROTECTIVE METHACRYLATE

MEDIDAS DE HUECO DE OBRA / CONSTRUCTION OPENING MEASUREMENTS





**MATERIAL  
PROMOCIONAL  
PROMOTIONAL  
MATERIAL**





# EXPOSITORES

CONSULTA LAS PROMOCIONES



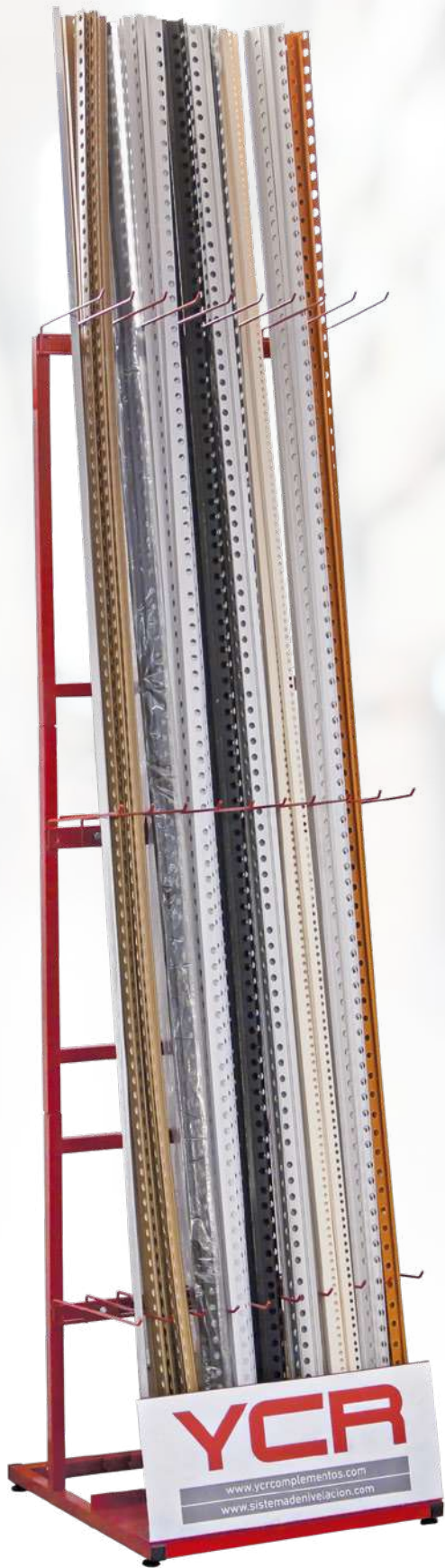

# YCR

**TEXTURIZADOS ALUMINIO**

Listeles Aluminio Rastico

AL040R12	AL040R12
AL040R12	AL040R12
AL040R12	AL040R12
AL040R12	AL040R12
AL040R12	AL040R12

Listeles Aluminio Lija #102

AL040L12 - 12 x 12 mm	AL040L12 - 12 x 12 mm
AL040L12 - 12 x 12 mm	AL040L12 - 12 x 12 mm
AL040L12 - 12 x 12 mm	AL040L12 - 12 x 12 mm
AL040L12 - 12 x 12 mm	AL040L12 - 12 x 12 mm
AL040L12 - 12 x 12 mm	AL040L12 - 12 x 12 mm

**TEXTURIZADOS PVC**

Guardacanta Curva Rastico 12 mm

AL040C12	AL040C12	AL040C12
AL040C12	AL040C12	AL040C12
AL040C12	AL040C12	AL040C12
AL040C12	AL040C12	AL040C12
AL040C12	AL040C12	AL040C12

Listeles Rastico 12 x 12 mm

AL040R12	AL040R12	AL040R12
AL040R12	AL040R12	AL040R12
AL040R12	AL040R12	AL040R12
AL040R12	AL040R12	AL040R12
AL040R12	AL040R12	AL040R12



## CONDICIONES GENERALES DE COMPRA.

La aceptación por parte del cliente del albarán y la correspondiente factura comercial sin objeción formulada por escrito dentro de los siete días a partir de la recepción de la mercancía, conlleva la conformidad sin reserva alguna de las siguientes condiciones de venta.

- La forma de pago de la mercancía será al contado, salvo que ambas partes acuerden una forma alternativa.
- Por acuerdo expreso nuestra responsabilidad se limita al cambio de las mercancías consideradas como defectuosas o equivocación en el etiquetado, con exclusión de cualquier otro tipo de indemnización.
- Todos los impuestos exigibles serán a cargo del cliente.
- Los precios de la presente tarifa no incluyen I.V.A., portes o cualquier otro tipo de impuesto o tasa.
- El valor mínimo para un pedido en la península y baleares a portes pagados es de 300,00 €. En el caso de Canarias, el pedido mínimo es de 1.000,00 €.
- Para pedidos inferiores a las cantidades señaladas, se cargará una contribución en concepto de:
  - 20,00 € para envíos en la península
  - 40,00 € para envíos a Islas Baleares
  - 95,00 € para envíos a las Islas Canarias

Todas las referencias de los artículos JUNTA DE DILATACIÓN JD10 y JUNTA DE DILATACIÓN JD11 tendrán las siguientes condiciones particulares de portes:

- El pedido deberá tener un valor mínimo de 300€ en la suma de dichas referencias para que sea a portes pagados. Independientemente del valor de la suma del resto de referencias incluidas en el pedido.
- En el caso de no alcanzar el valor mínimo de 300€ en dichas referencias, se cargarán adicionalmente 25€ en concepto de portes (península, Islas Baleares e Islas Canarias). Independientemente del resto del pedido.
- Todas las cantidades indicadas son netas.
- No estarán admitidas devoluciones de mercancías si no han sido acordadas con anterioridad con YCR Complementos, S.L.
- Serán aceptadas sólo si los productos están embalados en las confecciones originales e íntegras, de lo contrario serán rechazadas.
- Todos los artículos indicados en este catálogo están sujetos a la disponibilidad de YCR Complementos, S.L., que se reserva el derecho de efectuar modificaciones o de interrumpir la distribución en cualquier momento.
- Los precios amparados en el presente catálogo pueden ser modificados sin modificación de pre-aviso, en función de la variación de los índices base, subida de la materia prima y/o costos de producción.

Los perfiles de aluminio anodizados marcados con el símbolo  deben colocarse en interior y evitando la luz directa del sol.

Toda consecuencia a raíz de una mala colocación y/o mantenimiento, YCR Complementos, S.L. no se hará responsable de cualquier desperfecto.

## GENERAL PURCHASE CONDITIONS

The acceptance by the client of the delivery note and the corresponding commercial invoice without objection formulated in writing within seven days from the receipt of the merchandise, entails the unreserved agreement of the following conditions of sale.

- The method of payment for the orders will be as cash payment, unless both parties agree on an alternative form.
- By express agreement our responsibility is limited to the change of the merchandise considered as defective or mistake in the labeling, excluding any other type of compensation.
- All required taxes will be paid by the client.
- The prices of this rate do not include I.V.A., shipping or any other type of tax or fee.
- The minimum amount for an order in the peninsula and the Balearic Islands with carriage-paid deliveries is €300.00. In the case of the Canary Islands, the minimum order amount is €1,000.00.
- For orders less than the amounts indicated, a contribution will be charged as follows:
  - €20.00 for shipments in the peninsula
  - €40.00 for shipments to the Balearic Islands
  - €95.00 for shipments to the Canary Islands

All the codes of the articles EXPANSION JOINT JD10 and EXPANSION JOINT JD11 will have the following specific shipping conditions:

- The order must have a minimum value of €300 in the sum of said references to be freight prepaid. Regardless of the value of the sum of the rest of the references included in the order.
- In the case of not reaching the minimum value of €300 in said references, an additional €25 will be charged for postage (peninsula, Balearic Islands and Canary Islands). Regardless of the rest of the order.
- All amounts indicated are net.
- Products returns will not be accepted if they have not been previously agreed with YCR Complementos, S.L.
- Returns of products will be accepted only if the products are packed in the original and complete packaging, otherwise they will be rejected.
- All items listed in this catalog are subject to the availability of YCR Complementos, S.L., which reserves the right to make changes or discontinue distribution at any time.
- The prices covered in this catalog can be modified without prior notice modification, depending on the variation of the base indices, increase in raw material and/or production costs.

The anodized aluminum profiles marked with the  symbol must be placed indoors and avoiding direct sunlight.

YCR Complementos, S.L. will not be held responsible for any damage or consequence of poor placement and/or maintenance.





# YCR

**YCR COMPLEMENTOS S.L.**

C/ Lluís Santangel,43

Pol. Ind. Torrubero

46136 MUSEROS (Valencia)

Tel. 96 144 37 95



[info@ycrcomplementos.com](mailto:info@ycrcomplementos.com)

[www.ycrcomplementos.com](http://www.ycrcomplementos.com)

Exportación y Marketing: [ventas@ycrcomplementos.com](mailto:ventas@ycrcomplementos.com)

Pedidos: [pedidos@ycrcomplementos.com](mailto:pedidos@ycrcomplementos.com)

Contabilidad: [administracion@ycrcomplementos.com](mailto:administracion@ycrcomplementos.com)

Transporte y Almacén: [logistica@ycrcomplementos.com](mailto:logistica@ycrcomplementos.com)